

Guidelines for Good Hygienic Practice

**For Distributors and Operators of
Plumbed-in (POU – Point of Use) Water Coolers**



Revised: 5th September 2016

Table of Contents		Page
	Preface	3
Section 1	Definition of Terms & Abbreviations	4
Section 2	General Health, Safety & Hygiene	6
Section 3	Device selection and supply	6
Section 4	Installation requirements	7
Section 5	Design of Water Coolers	8
Section 6	Standards for Fittings, Materials & Filters	8
Section 7	Delivery to Customer / Storage of Coolers & Consumables on Customer Premises	9
Section 8	Commissioning	9
Section 9	Sanitisation: Cleaning & Disinfection	10
Section 10	Maintenance requirements	11
Section 11	Repair requirements	11
Section 12	Distribution Warehouses and Storage Facilities	12
Section 13	Gases	12
Section 14	Drinking Vessels	12
Section 15	Ordinances, Legal Provisions & Standards	13
Section 16	Avoiding Dangers / HACCP	15
Section 17	Training & Staff Development	14

Section 18	Environmental Management	14
Annex I	Tabular Overview: Safety & Monitoring measures – The Control Points	15
Annex IV	PoU Cooler Sanitization Recommendations. NSF International December 2013	23

Preface

Scope: these guidelines were drawn up to determine the requirements with regard to site, installation, hygienic operation, maintenance, cleaning and disinfection of plumbed-in water coolers and associated products like plumbed-in drinking devices. They should be read in conjunction with the operating instructions and/or the technical handbooks issued by the manufacturers or importers of the equipment.

WE, “Watercoolers Europe” is a non-profit organisation that represents the interests of the water cooler industry in Europe (bottled water coolers and plumbed-in (point-of-use) water coolers) and ensures that national and international quality standards for the water cooler industry are implemented. Besides of the existing European legislation the industry members are requested to comply with relevant existing national legislations.

In accordance with the principles of Watercoolers Europe (WE), these guidelines are intended to ensure that the highest standards are reached in the fields of quality, safety, hygiene and ethical behaviour in the water cooler industry. This aim can be achieved by ensuring that Distributors and Operators of Water Coolers are fully aware of their responsibilities to the environment and supply safe products and faultless services to their customers.

Within the meaning of Article 9 of European Regulation (EC) 852/2004, these guidelines for Good Hygienic Practice meet the objective of simplifying the application of the pertinent European legislation, particularly Regulation (EC) 852/2004 on the hygiene of foodstuffs.

These European “Guidelines for Good Hygiene Practice” were compiled with the aim of receiving official recognition from the European food monitoring authorities. However, these Guidelines do not take into consideration the parts of the European Code of Conduct (*Codex Alimentarius*) that are not relevant to hygiene.

The plumbed-in devices use water supplied from a distribution network, at the point, within premises or an establishment, at which it emerges from the taps that are normally used for human consumption, as defined by the Food Regulations and should be treated accordingly.

In accordance with the requirement detailed above, distributors and operators of plumbed-in water coolers must recognise their obligation to ensure the health and safety of consumers, from safe connection to the distribution network through to maintenance and cleaning and disinfection of the water cooler.

It is the constant aim of WE Technical Committees to improve the quality of our standards and services. We would be grateful if anyone finding an inaccuracy or ambiguity while using this WE CoP would inform the Secretary of the Association.

Section 1 Definition of Terms & Abbreviations

In these Guidelines, the important terms are defined as follows:

Ancillaries	Parts, components or products necessary to make the installed device complete and ready for operation
Bottled Water Cooler:	A watercooler used to dispense bottled water.
CCP: (Critical Control Point)	Critical Points (CP) in time or phases in the process (Process stages) which have to be monitored in order to eliminate hazards or to return the risk to below the permissible limit.
Cleaning:	Removal of soil, dirt, organic/inorganic deposits or other objectionable matter by means of water, mechanical action and/or chemical agents.
Commissioning:	Series of actions intended to put in operation the assembled system and to hand it over, as well as instruct the Keeper/Customes/Operator.
Competent person:	Individual or enterprise having the necessary qualifications in accordance with national regulation, if any, to be working on water conditioning devices.
Conditioned water:	Water passed through the water conditioning device to the distribution system.
Consumer:	The person who drinks water from the water cooler.
Contamination:	Unwanted influence on the product water by physical, chemical or biological contaminants.
CP: (Control Point)	A key point in process controls.
Customer/Keeper:	Individual or enterprise operating and monitoring the watercooler.
Device/Equipment/plumbed-in-watercooler/PE/PoU:	Water conditioning equipment in the scope of this European Standard complying with the relevant product standard (see [1] to [9]).
Disinfection:	Reduction in the number of undesirable micro-organisms through the use of suitable disinfectants and/or appropriate and specific physical methods.
Distributor:	A natural person or company, who sells, installs and/or services plumbed-in water coolers in a commercial capacity.
Domestic water distribution system:	Pipework, fittings and appliances that are installed between taps that are normally used for human consumption and the distribution network.
EU:	European Union.
Filters:	A water filter removes impurities from water by means of a fine physical barrier, a chemical process or a biological process.
HACCP: (Hazard Analysis & Critical Control Points)	System for monitoring food safety in a production process by determining specific dangers and setting out control points and measures.
Hazard:	Conditions which can have a detrimental effect on the health of consumers through their presence or absence. Hazards can be of a microbiological, chemical or physical nature.
Hygiene:	All necessary measures implemented during treatment, preparation and dispensing to consumers in order to ensure that the water is safe and fit for consumption.

Installation:	Permanent connection of the water conditioning device to the water distribution system including the electrical supply and ancillaries possibly needed for the correct operation of the equipment and for fulfilling the requirements of the relevant product standards (see [1] to [9]) and/or the existing legislation.
Keeper/Customer:	Individual or enterprise operating and monitoring the watercooler.
Maintainer:	Individual or enterprise performing maintenance.
Log book:	Document supplied together with the device or released to the keeper on which there are recorded the main actions required to be performed on the device during its lifetime starting from its commissioning. NOTE: The logbook in its simplest form could be a sticker.
Maintenance:	Periodic action for keeping and ensuring the continuous design performance of the device at the appropriate time, irrespective of the frequency of the required actions. NOTE Maintenance can include cleaning the watercooler and replacing predefined worn or exhausted parts
Manufacturer/Importer:	Enterprise that manufactures, assembles or imports the water conditioning device
Monitoring:	Planned series of observations which check whether possible hazards remain under control.
Operation:	Series of automatic and non-automatic actions undertaken for the correct functioning of the water conditioning
Operator:	A natural person or company, who leases, installs and/or services plumbed-in water coolers in a commercial capacity.
Owner:	Person responsible that the domestic water that consumers drinks is in compliance with Directive 98/83/EC
Point of Entry Watercooler/System (PE)	Watercooler/System used to treat all or part of the water for the premises inside buildings
Point of Use Watercooler/System (PoU)	Watercooler/System used to treat the water upstream from a single tap or multiple taps but not to the entire facility.
Removable:	Fabricated to be taken away from the system using no or simple tools (e.g. screw-drivers; pliers, open-end wrenches)
Repair:	Occasional action, performed by competent personnel only, intended to restore the performance of a defective water conditioning device.
Reverse Osmosis:	A treatment process in which the water, at high pressure, is passed through a semi permeable membrane which will remove some micro organisms and dissolved matter from the water.
Sanitisation:	Cleaning followed by disinfection.
Store:	A building (including temporary storage containers) used by the distribute or supplier to store and/or distribute drinking cups, water filters, water coolers, accessories & replacement parts, and for the repair, maintenance, cleaning and/or disinfection of water coolers.

Supplier	Enterprise that puts products and/or services on the market which may be the actual product manufacturer (e.g. Private brand name). NOTE: For the scope of this European Guidelines, the supplier is assumed to be sufficiently expert to undertake the task of providing clear instructions for the equipment installation, operation, maintenance and repair.
Water Cooler:	Appliance used to chill and dispense water for human consumption (Some may have a water heating facility).

Section 2 General Health, Safety & Hygiene

- 2.1 Distributors and operators of plumbed-in water and PE coolers must comply with the hygiene regulations and relevant water fittings regulations with regards to the supply and safety of drinking water to PE and PoU such that hygienic storage, distribution, installation and maintenance of the system components are ensured. It is the responsibility of the Manufacturers to design and construct cooling systems to aid cleaning and disinfection and to install such systems in a suitable, hygienic location and with suitable food grade water contact fittings and components. Distributors and Operators must compile appropriate information on the necessary health, safety and hygiene requirements, and must bring this to the attention of the end user responsible for the management and maintenance of plumbed-in water coolers and drinking cups. This must be documented in a suitable manner. Regard must be had to relevant health and safety Approved Codes of Practice.
- 2.2 Distributors and operators of plumbed-in water coolers must be familiar with the concepts developed by the WE regarding hygiene and the use of Hazard Analysis Critical Control Point (HACCP) which requires Operators to put in place, implement and maintain permanent procedures based on the HACCP Principles to eliminate or reduce biological, physical and chemical hazards to an acceptable level. The application of HACCP must be ensured by the operator of the water coolers and recommended by the distributor to the final customer. The distributor and operator must ensure the HACCP procedures are site and system specific.

Section 3 Device selection and supply

- 3.1 **Device selection and sizing.** Selection of a device that is appropriate to the performance and operational expectations, and to the intended installation site of the purchaser, is essential. Prior to purchase, information that is available in brochure form, specification sheets or that is clearly marked on the external product packaging, shall be available with the equipment, outlining the key installation and operation requirements. It shall specify limitations on the location for installation in terms of dimensional requirements and environment (e.g. temperature). It shall identify frequency of periodic operation and maintenance and the associated accessibility required. It shall also specify the water supply requirements (pressure limitations, pipe sizes) and proximity requirements for other services which may be necessary such as availability of electric power, drainage facilities etc.
- 3.2 **Device supply documentation.** All necessary information for installation, commissioning, operation and maintenance (stressing the importance of maintenance) shall be provided with the equipment so that it can be confirmed that the equipment is appropriate for the application, location, resources available, consumable requirements, etc.

Maintenance and repair services are presumed to be specialist activities and their availability shall be part of the product documentation.

As far as the repair is concerned, it shall be specified, whether the product requires disposal in case of failure/exhaustion (including instruction for disposal) or whether it can be restored almost to the original performance, if properly repaired.

All the documentation (e.g. label, logbook, instruction manual) provided to the customers with the device shall be presented in the official language(s) of the country in which the device is purchased.

Where the device is purchased including the service of installation and commissioning, this shall be clearly stated in the supply contract and the activities shall be conducted in accordance with the requirements of this European Guideline.

Section 4 Installation requirements

- 4.1 **General.** Proper installation of a device is a prerequisite not only for achieving the expected results but also for realising them continuously and safely.

Installation of devices shall be performed in accordance with national or local provisions.

If the device, as delivered, does not include the parts or ancillaries necessary to meet the relevant requirements and regulations, they shall be included in accordance with the equipment instructions during installation.

- 4.2 **Place of installation.** The water conditioning system shall be installed only in a suitable place (e.g. clean, well ventilated, adequately illuminated and protected against pests and frost) within the domestic water distribution system with sufficient and adequate water flow. It shall be remote or insulated from sources of heat (e.g. washing machines, dishwashers, boilers, cookers and hot water pipe work). Location shall take into consideration location of the existing distribution system as well as accessibility of other services (e.g. floor drainage may be essential under some circumstances).

Accessibility for operation and maintenance is, however, of high importance.

For cleaning and disinfecting purposes, water for human consumption shall be available. The drainage shall be suitably designed for collecting and discharging wastewater, where necessary.

- 4.3 The locations in which water coolers are installed are of great significance for their safe and hygienic operation. In general, plumbed-in water coolers should not be installed in the following locations:

- Where there is an increased risk of contamination, e.g. in dusty, unventilated or damp environments.
- On uneven or sloping surfaces or inside toilets.
- In escape routes
- Next to a heat source (e.g. heater or radiator)
- In locations that render cleaning and maintenance of the device difficult
- In places where the flow of water is not sufficient or can stagnate

- 4.4 Operator/distributor or keeper technical service identification must be marked on each device so as to be clearly visible.

- 4.5 At the installation location (customer premises), the distributor or operator must provide the persons responsible for the device with the manufacturer's operating instructions or a similar brochure containing information and care/maintenance tips for the water cooler and its safe, hygienic use.

- 4.6 The person responsible for the water cooler on the customer's premises must be informed of how to disconnect the supply of tap water to the water cooler at the shut-off valve. This valve must be easily accessible and clearly labelled.

- 4.7 In the event of a consumers warning of poor water quality coming from mains, owner, operators and keepers companies must contact their customers and inform them of the situation and to:

- a) Put each cooler out of use by turning off the shut-off valve in order to prevent consumers to taking water from it.

- b) Fix a notice to the cooler in a prominent position declaring that it is out of order and that water should not be taken from it.
- c) Not to consume the water until given by point b) go ahead by the cooler company
- d) Once the warning has been lifted by the competent water supplier or the competent regulatory authority and in the event that the installed water cooler could be contaminated by this poor water quality, water cooler must be cleaned and disinfected by the operator or the keeper before it is re-commissioned. Filters must be replaced at this time.

Section 5 Design of Water Coolers

- 5.1 The materials used in the water cooler and its design must comply with the applicable national requirements and European legislative requirements. In particular, water coolers must have a CE label showing electrical safety and must comply with EU machinery legislation as well as the EU legislation for electrical and electronic equipment – such as ROHS (Restricting use of Hazardous Substances) and WEEE (promoting the collection and recycling of such equipment).
- 5.2 In order to ensure that any negative impact on the water is avoided, all components of the water cooler being in contact with the water, including fittings, tubes and other parts must be in compliance with local requirements for materials in contact with drinking water or suitable as food contact materials if these requirements for water don't exist.
- 5.3 In addition water contact materials of the cooler should comply with any appropriate national legislation that governs the quality of fittings attached to a mains water supply.
- 5.4 Water coolers that are equipped with a facility for heating water must:
 - a) Be fitted with an appropriate warning label regarding the dangers of hot water. This should be in a position that is highly visible to the user, preferably next to the hot water tap.
 - b) Be fitted with a child-safety device.

Section 6 Standards for Fittings, Materials & Filters

- 6.1 When connecting water coolers to the network of mains water pipes, the technical requirements detailed in the European Directive 98/83/EC of 3 November 1998 related on the quality of water intended for human consumption must be taken into account.
- 6.2 Water coolers may only be connected to a designated suitable potable supply of water for human consumption.
- 6.3 Tanks or cisterns are not acceptable as sources of water, unless they comply with the statutory requirements and have been produced especially for water for human consumption use.
- 6.4 Fittings, pipes and hoses must be manufactured from materials suitable for foodstuffs and must fulfil the requirements of the appropriate laws. They should also comply with any appropriate national legislation that governs the quality of fittings attached to a mains water supply.
- 6.5 A shut-off valve and a check valve should be attached at the point where the water cooler is connected to the pipeline network. It is recommended to install a leak-prevention/overflow-prevention device at this point and to set this appropriately.
- 6.6 In installation locations where the water pressure exceeds the maximum operating pressure of the water cooler, the filters or the fittings at all times, or is liable to exceed it, a pressure reducing/pressure limiting valve (PRV) must be installed. Installing this type of valve is recommended if a pressure-increasing pump is used to increase water pressure.
- 6.7 When using water filters, the usage life recommended by the manufacturer must be observed, taking the water throughput and the usage time not exceeding 26 weeks into consideration.

The change of filters must be documented in a suitable manner. The type of water filters installed must be adapted to the local circumstances (e.g. the water quality) and be certified with the minimum NSF Standard 42 Class 1 or any equivalent European Standard.

- 6.8 In the event that a water cooler generates a flow of waste water as part of the filtering process, e.g. with reverse osmosis systems, the water flow must be discharged through an airbrake to drain or AA, AB or AD airgap that complies with the applicable statutory provisions.
- 6.9 In reverse osmosis systems, the membrane must be changed in accordance with the manufacturer's instructions.
- 6.10 All materials used that come into contact with the water must be free of rough surfaces and must be easy to clean and disinfect, or be replaceable. In particular, dead zones (areas of no/low water movement) and long periods of stagnation should be avoided.
- 6.11 **Hydraulic connection.** Connection to the piping of the domestic water distribution system shall comply with the following main requirements:

suitable backflow prevention shall be fitted where appropriate which complies with the national implementation of EN 1717.

device and the related fittings which require regular inspection for operation maintenance and repair purposes (e.g. water meters, check valves, anti-vacuum valves, air gaps, pressure gauges, stop valves, ancillaries), shall be easily accessible and should be kept unobstructed (e.g. by stored goods, furniture);

connections shall be made in accordance with the equipment instructions;

NOTE: To accommodate foreseeable (e.g. maintenance) or unforeseeable (e.g. failure) events, it is recommended, particularly for point of entry devices, that the installation can supply untreated water for human consumption downstream of the device (e.g. with bypass or isolation valves).

sampling taps shall be kept at relevant points for checking the device performance, where applicable.

Section 7 Delivery to Customer / Storage of Water coolers & Ancillaries on Customer Premises

- 7.1 Plumbed-in water coolers should be transported in suitable vehicles to ensure that they are delivered in a safe and hygienic condition.
- 7.2 During each stage of delivery to the customer, the water cooler must be:
- a) Packed correctly and effectively, to avoid the water cooler or the water dispensed from it becoming physically, chemically or microbiologically contaminated.
 - b) Treated with care and handled so as to avoid damage to the packaging,
 - c) Kept clean and in an undamaged condition.
- 7.3 Drinking vessels, particularly single-use cups, must be packaged when delivered, in order to protect them against the risk of contamination. Once unpacked it is recommended cups be stored in a cup dispenser in a clean dry place. For more Drinking Vessels information see Section 14.

Section 8 Commissioning

- 8.1 Detailed instructions on the commissioning steps shall be provided with the equipment. Commissioning is performed by a trained person and shall include any necessary operation (e.g. washing, regeneration, conditioning) and will replicate or mimic all the functional steps that occur during operation.

Appropriate checks shall be carried out to ensure that the equipment has been installed so that it is performing, and will continue to perform. The collected data on the commissioning shall be

recorded in the device logbook, if appropriate. During commissioning the device keeper should be trained to operate and monitor the device properly.

Documentation provided with the equipment should also be handed over.

Section 9 Sanitisation: Cleaning & Disinfection

- 9.1 Sanitisation of the water cooler must be carried out in accordance with the manufacturers' instructions. Sanitisation procedures must be effective and documented.
- 9.2 Sanitisation must be carried on all surfaces that come in to contact with or be in close proximity to the water including: reservoirs, internal pipe work, valves and taps.
- 9.3 Water coolers must be cleaned and disinfected (sanitised) before commissioning. Plumbed-in water coolers that are returned by the customer or received back after trial installation must be sanitised before recommissioning.
- 9.4 Sanitisation (See Section 9.1) must be carried out every 13 to 26 weeks. This must date from when the watercooler was last sanitized, not when it was delivered. Under certain conditions more frequent sanitisation maybe required.-

NOTE: Less frequency sanitisation maybe permitted where proven new technology is used (i.e. disinfection devices, new watercooler materials) Documented proof of the efficacy from an independent authorized entity must be provided before the use of such.

- 9.5 Distributors and operators of water coolers must provide all new customers with the manufacturer's operating instructions and these guidelines or another appropriate brochure, in which the necessity of regularly cleaning and disinfection of water coolers is explained, in line with point 9.4.
- 9.6 In principle, PoU owner and customers may choose between carrying out the sanitisation itself or having this carried out for it by the distributor or operator as part of a service package. If the customer, who operates the water cooler connected to a piped water supply, also carries out the sanitisation itself, the distributor or operator of the device must provide the customer with written information based on the pertinent legal provisions; which sanitisation methodology should be done, on the scope and frequency of sanitisation for the appropriate type of device and on any retrofitted sanitisation facilities.

At the same time, the distributor or operator must recommend that these tasks should be carried out by competent specialists and with products suitable for this use. The distributor or operator must document the fact that they have sent or given the customer the instructions/information.

- 9.7 The sanitisation procedures carried out by the distributor or operator either on the customer's premises or back at the distributors/operator facility, must be documented in a suitable manner (date, person carrying out the procedure and sanitisations, agents used and any observations or issues encountered).
- 9.8 Staff responsible for the installation of water coolers and their sanitisation must comply with the requirements pertaining to personal hygiene and may only use suitable procedures, equipment and materials in their work. The staff must have completed suitable training in hygiene, cleaning and maintenance carried out by the device manufacturer, the distributor, their agents, a suitable third party or by a WE approved trainer.
- 9.9 All resources that are employed in the sanitisation of water coolers must be suitable for use in areas where foodstuffs are prepared and must comply with the following criteria:
 - a) Suitability with regard to composition and concentration, taking the materials used in the water cooler into account. The manufacturer's recommendations for cleaning and disinfection agents must be observed, as must the recommendations of any sanitisation device manufacturer.
 - b) Storage with no risk of contamination prior to use.
 - c) Able to be washed out thoroughly, in order to prevent the build up of biofilm.
 - d) Single use and possibility of disposal.

Depending on sanitisation methods the system must be flushed out thoroughly and the water must be inspected to ensure it is free of sanitisation agents, using appropriate methods.

- 9.10 All data collected during commissioning and normal operation, maintenance and repair operations shall, be recorded in the logbook that accompanies each device.

Section 10 Maintenance requirements

- 10.1 **General** Maintenance consists of routine and periodic actions at least once per year that are needed to prevent malfunction, failures, loss of performance etc. It concerns easily accessible and removable parts or components only, and can be performed by a relatively unskilled individual without safety risks.

After each maintenance operation that involves parts in contact with water to be consumed, sanitization must be done at least once per year. Depending on the technology available to the installed equipment, this interval may be longer as long as it is demonstrated by appropriate certification by a reputable third independent entity.

The maintenance protocol is provided with the equipment.

The continued efficient functioning of the installation relies upon regular maintenance of the installed water conditioning device. Regular inspection of plastic tubes must be done. Tubing must be replaced if there is any evidence that the installed tubes being brittle or degradation.

The owner of the water conditioning device is strongly recommended to conclude a maintenance contract. All spare parts including disposables should be obtained from the equipment manufacturer.

If equivalent alternatives are adopted, they shall be suitable for the relevant equipment and application in accordance with the relevant product standards (see [1] to [9]).

- 10.2 **Maintenance elements.** The following elements should be part of the maintenance work:

- a) raw and treated water tests, where appropriate, to the application;
- b) evidence of effective operator attention (e.g. presence of salt in brine tank);
- c) control of the bypass valve, if required to be installed;
- d) cleaning and disinfecting, if applicable;
- e) replacement of worn, exhausted and/or disposable parts.

If for any reason and in spite of maintenance the leased device cannot be restored to the optimum operating conditions, the device shall be taken out of service.

Section 11 Repair requirements

- 11.1 **General.** Device repair is aimed at supplying expert attention for emergency breakdown.

Repairs shall be performed in accordance with the equipment instructions and the device technical manual. Competent people shall be properly instructed and trained to repair the specific brand and type of device.

All spare parts including disposables should be obtained from the equipment manufacturer.

If equivalent alternatives are adopted, they shall be suitable for the relevant equipment and application in accordance with the relevant product standards (see [1] to [9]).

A detailed report of the intervention shall be recorded in the device logbook.

- 11.2 **Repair or breakdown.** Any repair shall be performed by isolating the device, if necessary.

During repair particular care shall be taken to prevent any contamination of the inlet (feed) and outlet (treated) water.

After repairing parts in contact with water, the device shall be examined as indicated in 10.2 and, if necessary, commissioned as per installation procedure.

If the leased device cannot be restored to the optimum operating conditions, the device shall be taken out of service.

Maintenance operations that require dismantling the system, such that water contact parts are exposed, should be subject to careful, hygienic control to avoid contamination of the system. Preferably, disposable gloves should be used to avoid personal contamination of the system parts; any tool used that may come into contact with the wetted parts should be cleaned and disinfected in accordance with the instructions before use.

For example, for filters, the spent cartridge should carefully be disposed of and the replacement cartridge should remain sealed in its protective wrapping until the last practical moment.

Section 12 Distribution Warehouses and Storage Facilities

- 12.1 For facilities that are used to store water coolers and accessories or replacement parts, safety and device hygiene must be guaranteed in accordance with the statutory requirements.
- 12.2 A warehouse must be under the direct supervision of a responsible person who has been trained in warehouse management, hygiene and safety.
- 12.3 A warehouse must be under regular pest control programme.
- 12.4 Prior to starting work, and at regular intervals all persons employed by distributors or operators of plumbed-in water coolers (with the exception of administrative and sales personnel), must be trained in all aspects of personal hygiene, health and safety, device and product hygiene, as appropriate to their areas of work and in accordance with the statutory requirements. These training courses must be documented.

Section 13 Gases

- 13.1 In the event that gases (e.g. carbonation) are used in the water cooler, only gases and gas containers that have no hygienic flaws may be used, in order to prevent contamination of the system. The gases must be authorised as food additives/for use in foodstuffs (with an official Declaration of Compliance). In addition, it must be ensured that the outside of the gas bottle is also completely hygienic, particularly in the valve area. When dealing with gases, notably with carbon dioxide or oxygen, the distributor or operator must comply with the operating instructions from the manufacturer of the water cooler. In particular, the safety provisions and site conditions must be taken into account.
- 13.2 A double check valve must be installed between the gas supply facility (pressure reducer, hoses) and the water cooler, in order to rule out the possibility of water flowing back into the gas line(s). Gas cylinders should be secured so as to prevent them falling over during storage, transportation, and its installation at customer premises.

Section 14 Drinking Vessels

- 14.1 Distributors and operators may only use drinking vessels and cups intended for use at water coolers that comply with the pertinent provisions of food law. The water must not be affected in any way by the environment and the handling of vessels during use.

- 14.2 In so far as Distributors and operators supply cups for use with hot water, these cups must be designed so as to withstand the temperature of the drawn water without distortion, heat transfer or the risk of scalding the consumer.
Cups that do not meet these requirements must be clearly labelled accordingly, so it is clear to the end-user that the cups are not fit for the purpose of use with hot water. The container for used cups must be clearly labelled.
- 14.3 When disposing of single-use cups, distributor and operators that sells cups shall guarantee disposal in accordance with the national requirements and will explore and offer recycling options as practical.

Section 15 Ordinances, Legal Provisions & Standards

- 15.1 Distributors, operators, manufacturers and importers of water coolers connected to mains water pipelines must keep themselves, and the staff working with such water coolers, up to date with regard to current legal provisions relevant to water for human consumption and water coolers and must ensure that their staff have access to training to understand the pertinent legal provisions and standards, in so far as this is necessary for their work.
- 15.2 A list of the provisions to be taken into account is included in the Annex III; the relevant valid version of these provisions should be consulted.

Section 16 Avoiding Dangers / HACCP

- 16.1 Operators and distributors of plumbed-in water coolers must have an HACCP document that is adapted to the individual requirements of their company and their products.

In principle, an HACCP model must be tailored to the company; each company must carry out at least one HACCP analysis periodically for its processes and products. Subject to the prerequisite that all the general hygiene rules (measures of good hygiene practice) are implemented and observed, the HACCP analysis must include a decision on whether additional safety measures are necessary. Consequently, these measures should be determined, observed and examined regularly, with the aim of guaranteeing the safety of the water issued to the consumers (essence of the HACCP concept).

The HACCP and the determination of an HACCP model must include the following steps:

- Hazard Analysis and Risk Assessment
- Identification of Critical Control Points (CCPs), where checks are necessary in order to avoid dangers, eliminate them or reduce them to acceptable levels, and identification of further Control Points (CPs) if appropriate.
- Determination of limit values/management criteria for the Critical Control Points
- Determination of the implementation of efficient procedures for monitoring the Critical Control Points
- Determination of corrective measures for the event that a Critical Control Point reveals a problem
- Determination of regular verification procedures to ensure corrective measures are implemented
- Compilation of appropriate documents and records showing dates of corrective measure implementation, updated analysis of HACCP processes etc.

Due to the fact that the processes and products involved in the distribution and operation of plumbed-in water coolers can easily be compared, the responsible parties can follow the model hazard analyses and HACCP concepts very closely. However, it is a precondition that all enforceable and recommended hygiene rules and measures are observed.

Within the framework of these Guidelines, for example, an overview of “Safety and Monitoring Measures at Critical Points” is provided (see ANNEX I). This overview applies to a typical distribution process and is based on a consideration and assessment of the hazards that experience suggests may exist (hazard analysis/risk assessment) to deal with:

- Contamination of the water cooler and/or defects already present upon receipt of goods
- Microbiological contamination of the water due to a lack of hygiene during transport through mains or plumbed-in systems, during execution of maintenance or sanitisation measures or as the result of incorrect use by the consumer.

Critical Control Points (CCPs) – that is Control Points with a bearing on safety – do not typically arise in these processes; the management and monitoring measures are more concerned with correcting and eliminating negative influences at Control Points relevant to hygiene.

- 16.2 Distributors and operators of plumbed-in water coolers must have a system for recording any customer complaints, where relevant details on each complaint and on the remedial measures taken should be noted. (The system must be inspected regularly and any trend must be assessed, so that potential risks can be detected early and precautions taken against them.)

Section 17 Training & Staff Development

- 17.1 Prior to starting work, all persons employed by Distributors or operators of plumbed-in water coolers (with the exception of administrative and sales personnel), must be trained in all aspects of personal hygiene, health & safety, device & product hygiene, as appropriate to their areas of work and a qualification to install a main fed water cooler may be required in accordance with the statutory requirements.
- 17.2 The training sessions detailed in Point 17.1 must be repeated periodically and must be documented in an appropriate manner.

Section 18 Environmental Management

- 18.1 Distributors and operators of water coolers undertake to consider environmental protection when selling and operating the devices.
- 18.2 In particular, the distributors and operators of the devices shall use the most environmentally-friendly agents possible for sanitisation and maintenance of the devices, shall limit the outlay for packaging and transport and the operator shall guarantee that the water coolers, all packaging, drinking cups, used replacement parts and cleaning agents are disposed of in accordance with statutory requirements.
- 18.3 Only qualified specialist companies shall be entrusted with disposal of the materials mentioned under Point 18.2.
- 18.4 When disposing of water coolers, the distributors, operators or owners shall observe the requirements of the device manufacturer in accordance with the provisions of the EU legislation on Electrical and Electronic Equipment and, if appropriate, shall supply the necessary evidence of disposal.
- 18.5 The disposal measures implemented must be documented in an appropriate manner.

Annex I

OVERVIEW IN TABLE FORM: SAFETY AND MONITORING MEASURES – THE CONTROL POINTS:

NOTE: This Annex is a model made on the basis of their most common activities on PoU Water Coolers Distributors and Operators sector performed in the period of implementation of the present Guidelines for Good Hygienic Practice. This Annex can be modified depending on the future needs and technical developments of the sector as long as these changes to enforce the laws applicable in the different EU member states legislations.

Process stage: GOODS RECEIPT

Procedure	Risks Danger(s)	Precautionary measures	CP/CCP	Critical limit(s)	Monitoring	Corrective measures
Incoming water cooler	Contamination of the water cooler and possible defects	CE symbol; own specifications. Water inlet quality must be disinfected and in compliance with legislation of water for human consumption	CCP Water cooler	Internal standards, standards of the Machinery Directive	Inspection upon receipt, in accordance with spot check plan	Feedback to the supplier Elimination of the defect
Transport	Knocks during transport	Resistant packaging	CP Water cooler	Without external impacts	Inspection upon receipt, in accordance with spot check plan	Feedback to the supplier Elimination of the defect

Process stage: SALES

Procedure	Risks Danger(s)	Precautionary measures	CP /CCP	Critical limit(s)	Monitoring	Corrective measures
Transport	Microbiological contamination, transfer of odours and flavours	Use only transport containers that are exclusively intended for transport of no taint stuffs	CP Transport containers	Internal standards	For each delivery, a declaration must be obtained stating that the goods are clean and hygienically safe.	Renewed Cleaning and Disinfection if necessary; feedback to the haulage company

Process Stage: SERVICING AND HYGIENIC MAINTENANCE OF WATER COOLERS

Procedure	Risks Danger(s)	Regular and precautionary measures	CP /CCP	Critical limit(s)	Monitoring	Corrective measures
Distribution of Cleaning and Disinfection instructions	Microbiological contamination due to a lack of hygiene	Inlet water complying with appropriate EU Directive Intensive Sanitisation of the Water Cooler, as appropriate for the device and in accordance with manufacturer's instructions	CP Reservoir, connecting pieces and taps	Internal standards Cleaning requirements	Internal maintenance plan	Renewed Sanitisation of the Water Cooler
Hygienic maintenance	Microbiological contamination due to a lack of hygiene	Inlet water complying with appropriate EU Directive Sanitisation of the water cooler Sample point installation prior to PoU installation point.	CP All water contact surfaces: Filter, water tanks, rubber seals, pipes, valves,...	Internal standards	Internal maintenance plan	Change of PoU water contact parts
	Chemical contamination due to not enough rinsing of chemicals used on the Sanitisation process	Check the possible residue of chemicals used in the sanitisation process	CP All water contact surfaces: Filter, water tanks, rubber seals, pipes, valves,...	Absence of used chemical	Internal maintenance plan (Records of precautionary measures)	Change of PoU water contact parts.
Use by the consumer	Microbiological contamination due to incorrect usage	Appropriate operating instructions and maintenance written information given to Responsible Person at end-user location to distribute to users	CP Water Cooler	Internal standards	Checks on maintenance, Sanitisation, with reference to documentation of events	Adaptation of the maintenance, operating and usage instructions to new circumstances

Annex II

EXAMPLE OF OPERATING INSTRUCTIONS FOR THE CUSTOMER / OPERATOR / DISTRIBUTOR

1. Safety instructions

- Please read the instructions supplied carefully before commissioning the device, in order to comply with all the safety provisions.
- The water cooler must comply with the current European Union requirements. For this reason, it must be labelled with the CE inspection symbol. Please check that the CE symbol is present, and if desired, request of the manufacturer/importer documentation of the tests used to comply with CE. Ideally, these are evidenced by a report from a third party inspection entity.
- The installation of the water cooler must only be carried out by authorised specialists.
- In order to ensure your safety and compliance with statutory regulations, changing of the pressurised gas container should only be carried out in strict compliance with the relevant instructions for installing or changing the pressurised gas container. The pressurised gas container must always be in a vertical position and be secured so as to prevent it falling over.
- Any repairs to the water cooler may only be carried out by an authorised, qualified technician.
- Any interventions or device installations that are not described in the usage instructions may only be carried out by authorised, qualified personnel.
- The usage instructions shall only be valid in conjunction with the original manufacturer's instructions supplied. In cases of doubt, the original manufacturer's instructions shall be binding.

2. Notes on Location

- The water cooler must be placed on a horizontal surface that can bear the weight of the cooler and any pressurised gas container (in accordance with the technical data sheet).
- The water cooler must be positioned so that sufficient ventilation and exhaust is always possible.
- The water cooler should not be positioned in the vicinity of direct or indirect sources of heat unless the water cooler is proved prepared for it (e.g.: ovens, radiators, stoves, coffee machines, etc.).
- The water cooler should also not be positioned in circulation routes or in escape routes.
- The regulations regarding the maximum permitted CO₂ concentrations should be observed, with relation to the size of the room.
- No objects may be placed on the water cooler.
- The water cooler should be positioned close to the energy supply and the water connection, minimising the length of tubing.

- The energy supply and the water connection must be suited to the characteristics of the water cooler, which are described in the technical datasheet.
- The electricity cable and the water supply must be routed so that they do not interfere with one another.
- The metallic & polymeric material feed tubing must not be laid where the feed water may become warm (e.g. hot water pipes, light fittings, central heating, etc.) avoiding stagnant water.

In the event that the water cooler has not been kept in a vertical position during transport or installation, the device must be placed in a vertical position and at least 24 hours must pass prior to commissioning.

3. Connecting to the Water Supply

- No temporary connections may be established. Furthermore, the following interventions are advisable to carry them out by authorised, qualified specialists: non return valve that must be installed between the water cooler and the water supply
- Fitting of a water stop/anti leak device (electrical or mechanical), at the take off point from the mains supply is advised to prevent damage by flooding.

The water connection must comply with the following characteristics, in order to ensure that the water cooler can be operated safely without any faults occurring.

- The water pressure must be determined. In the event that the pressure is higher than that recommended by the manufacturer a pressure reducer must be fitted immediately downstream of the water shut-off valve at the connection to the mains supply, to bring the pressure into line with the manufacturer's instructions.
- The pipes and connections used for the water conduits must be in compliance with local requirements for materials in contact with drinking water or suitable for foodstuffs if these requirements don't exist. Special accessories, such as filters, which may be installed in the distribution network if appropriate, must also be suitable for foodstuffs and should also comply with any appropriate national legislation that governs the quality of fittings attached to a mains water supply.

4. Maintenance

- The following overview shows all the common and schedule maintenance procedures that must be carried out at the intervals determined.
- These intervals are based on normal use of the water cooler. More intensive use of the cooler may mean that more frequent maintenance is required.
- The water coolers should never be disconnected from the electrical power for periods no longer than 48 h unless technology is available that makes the dispensed water is not affected by this stoppage in compliance with water for human consumption Directive.

In the event that the water cooler has not been used for a relatively long period of time (two to three days), it is recommended that three to four litres of each type of water be drawn before drinking

COMPONENT	TYPE OF ACTIVITY	SCHEDULE				To be carried out by:
		daily	weekly	every 6 moths	yearly	
External housing, external and front panels	Cleaning	X				Customer following manufacturer/importer instructions (e.g. with commercial mild Cleaning agent)
Water outlet	Hygiene		X			Customer following manufacturer/importer (e.g. with a hydrogen peroxide or other food grade disinfectant spray or wipes)
Drip catcher	Emptying	X				Customer following manufacturer/importer
	Cleaning		X			Customer following manufacturer/importer (e.g. under running water with commercial mild Cleaning agent)
Ventilation slits	Cleaning			X		Customer following manufacturer/importer (e.g. with a dry brush or a cloth)
Water Cooler	Hygiene			X		Specialist staff working for the operator or distributor or authorised, qualified specialist following manufacturer/importer
Water filter	Replacement			*	*	Specialist staff working for the operator or distributor or authorised, qualified specialist following manufacturer/importer
UV bulb	Replacement				X	Specialist staff working for the operator or distributor or authorised, qualified specialist following manufacturer/importer

*** The filter must be replaced either every 26 weeks, in accordance with the manufacturer's instructions and volume of consumed water.**

After each maintenance operation that involves parts in contact with water to be consumed, sanitization will be done.

5. Maintenance Recording

5.1 General

The maintenance events and all operations performed during maintenance (see Section 10.2) shall be carefully recorded in the logbook after each maintenance intervention.

The logbook shall contain at least two types of information: general and specific (see below). The following minimum general information about the device shall be recorded in the logbook:

- a) device type and identification;
- b) device location, if applicable;
- c) owner/keeper coordinates;
- d) maintainer coordinates;
- e) name of the actual maintainer;
- f) date of commissioning;
- g) date of the intervention;
- h) type of intervention (see Annex II. 5.2).

5.2 Type and description of the intervention (check-list)

The following check list is not exhaustive and shall be adapted to each type of water conditioning device.

The listed items below should be included in the maintenance programme and recorded in the logbook in compliance with the relevant equipment instructions:

- a) hydraulic controls;
- b) control of the pertinent test parameters, where appropriate to the application;
- c) cleaning of the components in accordance with the instructions;
- d) replacement of parts as per maintenance protocol;
- e) check consumption of consumables (e.g. salt, chemicals);
- f) check of correct functioning of the assembled device;
- g) visual inspection for damage (leakage, corrosion, scaling);
- h) other maintenance operations as appropriate (e.g. lubrication, integrity of resins, membranes).

Annex III

REFERENCES: ACTS, ORDINANCES, PROVISIONS, STANDARDS AND INFORMATION

- [1] EN 13443-1, *Water conditioning equipment inside buildings — Mechanical filters — Part 1: Particle rating 80 µm to 150 µm – Requirements for performances, safety and testing*
- [2] EN 13443-2, *Water conditioning equipment inside buildings — Mechanical filters — Part 2: Particle rating 1 µm to less than 80 µm — Requirements for performance, safety and testing*
- [3] EN 14095, *Water conditioning equipment inside buildings — Electrolytic treatment systems with aluminium anodes — Requirements for performance, safety and testing*
- [4] EN 14652, *Water conditioning equipment inside buildings — Membrane separation devices — Requirements for performance, safety and testing*
- [5] EN 14743, *Water conditioning equipment inside buildings — Softeners — Requirements for performance, safety and testing*
- [6] EN 14812, *Water conditioning equipment inside buildings — Chemical dosing systems — Pre-set dosing systems — Requirements for performance, safety and testing*
- [7] EN 14897, *Water conditioning equipment inside buildings — Devices using mercury low-pressure ultraviolet radiators — Requirements for performance, safety and testing*
- [8] EN 14898, *Water conditioning equipment inside buildings — Active media filters — Requirements for performance, safety and testing*
- [9] prEN 15219, *Water conditioning equipment inside buildings — Nitrate removal devices — Requirements for performance, safety and testing*
- [10] 98/83/EC, Council Directive of 3 November 1998 on the quality of water intended for human consumption
- [11] EN ISO 9000, *Quality management systems — Fundamentals and vocabulary (ISO 9000:2005)*
- [12] EN ISO 9001, *Quality management systems — Requirements (ISO 9001:2000)*
- [13] 89/106/EC, Council Directive of 21 December 1989 on the approximation of laws, regulations and administrative provision of the Member States relating to construction products
- [14] 99/44/EC, European Parliament and Council Directive of 25 May 1999 on certain aspects of the sale of consumer goods and associated guarantees
- [15] WHO/SDE/WSH/02.10, *Heterotrophic Plate Count Measurement in Water for human consumption Safety Management — Protection of the Human Environment Water, Sanitation and Health / WHO World Health Organization Expert Consultation — Geneva 24-25 April, 2002*
- EN 15161, *Water conditioning equipment inside buildings — Installation, operation, maintenance and repair*
- EN 1717, *Protection against pollution of water for human consumption in water installations and general requirements of devices to prevent pollution by backflow*
- Regulation (EC) No. 852/2004 of the European Parliament and of the Council of 29 April 2004 on the hygiene of foodstuffs
- Regulation (EC) No. 1935/2004 of the European Parliament and of the Council of 27 October 2004 on materials and articles intended to come into contact with food and repealing Directives 80/590/EEC and 89/109/EEC

Regulation (EC) No. 10/2011 of the European Parliament and of the Council of 14 January 2011 on plastic materials and articles intended to come into contact with food.

Directive 98/37/EC of the European Parliament and the Council of 22 June 1998 for equivalence of the Member States' legal and administrative provisions pertaining to machines

Employer's Liability Insurance Regulation BGV A3 "Electrical systems and equipment"

DIN 6650 "Drinking Dispensers"

DIN EN ISO 14159 Safety of Machines - Hygiene Requirements relating to the Design of Machines

DIN 10514 Food hygiene - Hygiene training

DIN 10516 Food hygiene - Cleaning and Disinfection

DIN 2000-10 Central provision of water for human consumption - Guidelines for requirements with regard to water for human consumption, planning, construction, operation and maintenance of supply systems - DVGW technical regulation

DIN 50930-6, Corrosion of metals - Corrosion of metallic materials inside pipes, containers and apparatus when exposed to corrosion by water - Part 6: Influence on the properties of water for human consumption

DIN 50931-1, Corrosion of metals - Corrosion tests with water for human consumptions - Part 1: Testing the changes in the properties of water for human consumption

DVGW W 270 Multiplication of micro-organisms on materials for the water for human consumption sector – Test and Evaluation

DIN 1988 Technical Regulations for Water for human consumption Installations (TRWI) - Special publication - Technical Regulation issued by the DVGW

BGR 228 "Installation and Operation of Drinks Dispensers"

ASI 6.80 "Pressurised Gases for Supplying Drinks Dispensers"

HACCP concept, Bundesverband der Deutschen Vending-Automatenwirtschaft e.V. (bdv)

HACCP concept, German Bottled Water Association e.V. (GBWA)

VDI 6023 Sheet 1 (1998) "Hygiene-conscious planning, installation, operation and maintenance of water for human consumption systems"

Annex IV

POU Cooler Sanitization Recommendations NSF International November 2015

POU coolers by definition include certain technologies to treat the water prior to the water being dispensed for the consumer. Treatment includes filtration, reverse osmosis, ultraviolet, and other technologies. These types of treatment can conform to certain NSF/ANSI Standards and NSF Protocols for POU treatment, including:

NSF/ANSI 42 Water for human consumption treatment units – Aesthetic effects

This standard addresses the safety of materials in contact with water for human consumption, the structural integrity of products subject to line pressure, claims of treatment of aesthetic contaminants such as chlorine and particulates that may be present in the water for human consumption, and product literature requirements, for both complete systems and components of complete systems.

NSF/ANSI 53 Water for human consumption treatment units – Health effects

This standard addresses the safety of materials in contact with water for human consumption, the structural integrity of products subject to line pressure, claims of treatment of health contaminants such as lead and volatile organic contaminants that may be present in the water for human consumption, and product literature requirements, for both complete systems and components of complete systems.

NSF/ANSI 55 Ultraviolet microbiological water treatment systems

This standard addresses the safety of materials in contact with water for human consumption, the structural integrity of products subject to line pressure, claims of disinfection (Class A) or inactivation of non-pathogenic nuisance organisms (Class B), and product literature requirements, for both complete systems and components of complete systems.

NSF/ANSI 58 Reverse osmosis water for human consumption treatment systems

This standard addresses the safety of materials in contact with water for human consumption, the structural integrity of products subject to line pressure, claims of treatment of Total Dissolved Solids (TDS) as well as health contaminants such as lead and volatile organic contaminants that may be present in the water for human consumption, and product literature requirements, for both complete systems and components of complete systems.

NSF P231 Microbiological water purifiers

This protocol addresses the safety of materials in contact with water for human consumption, the structural integrity of products subject to line pressure, claims of microbiological treatment of water of unknown microbiological quality to render it potable, including 6 log bacteria reduction, 4 log virus reduction, and 3 log cyst reduction, and product literature requirements, for complete treatment systems.

Questions have arisen regarding the sanitization of POU coolers, and whether POU coolers incorporating POU treatment that conforms to *NSF P231 Microbiological water purifiers* should require sanitization. Conformance to NSF P231 does indeed mean that incoming water that may have microbiological contamination issues due to problems with distribution system, etc., can be effectively treated and safely consumed after treatment.

However, treating contaminated water effectively does not necessarily mean that periodic sanitization of the cooler is not needed. Even with devices that include POU treatment conforming to NSF P231 can develop microbiological issues in several ways, including, but not limited to:

- Contamination during maintenance. As filters are changed, etc., contamination on the upstream side of the filter can be unintentionally carried through to the downstream side, resulting in contamination of the system.

- Contamination from the dispenser. Users may touch the dispenser with their hands, etc., and contaminate the dispenser. This contamination can potentially enter the water downstream of any POU treatment and cause harm to those drinking the water.
- Growth of biofilm. Although biofilm itself may not be a health issue, it can certainly be an aesthetic issue for those drinking the water. And POU treatment conforming to NSF P231 does not necessarily prevent the growth of biofilm downstream of the POU treatment. Additionally, biofilm can become an environment hospitable to various pathogens, should the reach the biofilm through an event such as contamination during maintenance or contamination from the dispenser.

Given this potential for microbiological contamination of POU coolers, even those including treatment conforming to NSF P231, NSF recommends periodic effective sanitization of the POU coolers.

Annex V

Standard Methodology for the examination of microbiological grow efficiency of Point of Use sanitisation methods.

The following standard methodology was developed by the Watercoolers Europe Standards Committee in March 2009 and approved by the General Managers Associations Meeting during the EBWA Trade Fair and Convention held in Barcelona on 20th to 22nd of October of 2009.

This Standard methodology is a developed tool to demonstrate that the sanitization procedures provided by manufacturers, operators and distributors members to its customers are efficient. However, this standard methodology is not mandatory for our members at the date of issue of this CoP.



STANDARD METHODOLOGY FOR THE EXAMINATION OF THE MICROBIOLOGICAL EFFICIENCY OF POINTS OF USE SANITISATION METHODS

MODULE THREE

THE CHALLENGE TEST - POU

Effectiveness of Sanitisation Methods in Removing Pathogens

The Challenge Test is intended to allow manufacturers of “Point of Use watercoolers” (from now POU) to provide their customers with a method of machine sanitisation (cleaning and disinfection) that has been proven to work to EBWA standards, even when a POU is heavily contaminated with pathogenic bacteria.

This test involves the deliberate contamination of POU with “*Pseudomonas aeruginosa*” and the undertaking of a Full Sanitisation. Once the sanitisation is completed, the *Pseudomonas aeruginosa* is allowed to re-grow for period of 14 days in order to test the ability of the organism to re-contaminate the machine after sanitisation. Water drawn from the point of use is tested, rather than an internal water contact surface being swabbed.

SCOPE

- The aim is NOT to demonstrate that POU treatments (carbon filters, Reverse Osmosis, UV, decalcification...) are able to remove or prevent the contamination with *Pseudomonas aeruginosa*, but proving that an efficient sanitisation of the POU under test is achievable when the manufacturer's instructions and recommended sanitisation methods are followed when a POU is contaminated microbiologically.
- Easing the identification of causes, remedies and responsibilities concerning microbiological contamination of POU in the field.

BENEFITS OF STANDARDISED TEST METHODOLOGIES

- **MODULE THREE - POU**

Demonstrates, on both quantitative and qualitative basis that a pathogen infected POU can be successfully sanitised.

Being aware of the great variability of tests carried out by POU manufacturers throughout Europe, it is considered essential to have a test which ensures that sanitisation of these machines is common for all EBWA members.

EBWA REQUIREMENTS

MODULE THREE-POU

This module may be submitted by manufacturers as the mandatory Module for EBWA Supplier members, or by those intending to show at EBWA Trade Shows. Other than that, the Challenge Test - POU is an optional test, except in those countries where the National Association's Code of Practice may require it.

NOTES:

- 1) Testing and Certification indicating that products have attained the EBWA standards must be undertaken by approved and accredited third party test facilities.
- 2) Certification does not imply, or grant, EBWA approval or endorsement of the product tested. Strict guidelines relate to the use of such Certification in advertising and marketing material.
- 3) POU and equipment manufacturers who consider that they are unable to execute the present test on their equipment or with their products, should submit an alternative proposal (before commencing any testing) to the Protocol Results Evaluation Sub-Committee of the EBWA Standards & Technical Committee (called forthwith the EBWA Protocol Evaluation Sub-Committee), who will determine if the alternative protocol is acceptable.

SANITISATION METHODS

a) *Cleaning*

The objective is to physically remove as much scaling and bio-film as possible. This can be by:

- Use of a descaler
- Use of a detergent
- Physical cleaning using brushes and/or cloths

Descalers are especially effective and simultaneously achieve a reasonable kill of bacteria, whilst cleaning hard to access areas

b) Disinfection

Materials may include the use of:

- Chlorine compounds
- Hydrogen Peroxide (H₂O₂)
- Peracetic acid (PAA) and others Peroxides
- Ozone (including permanently fitted ozonation devices)
- Steam (including internal steam generating devices)
- Hot water

c) One Step Sanitisation

- Replacement by pre-sanitised or disposable components

METHODS CLAIMING REDUCTION OF FREQUENCY OF SANITISATIONS

Equipment/materials claimed to reduce the need for Full Sanitisations below those specified in the EBWA Code of Practice of 4 per year include:

- Antibacterial plastics
- In-place heating devices
- In-place ozonation devices

NOTE: Use of antibacterial materials for water contact surfaces or ozonation devices must comply with any existing National Legislation.

METHODOLOGY

MODULE THREE: THE CHALLENGE TEST - POU

The Challenge Test - POU involves contamination of POU with "*Pseudomonas aeruginosa*" before undertaking sanitisation using a method provided by the machine manufacturer. *Pseudomonas aeruginosa* is allowed to re-grow for a period after sanitisation in order to test the ability of the organism to continue to contaminate the POU after the sanitisation. The water dispensed by the POU is tested, rather than a swab of an internal water contact surface.

Module Three-POU has been created to assure national and other regulatory authorities of the preparedness of the POU industry for any potential contamination crisis.

The prescribed testing method is aimed at proving that pathogenic contamination of the POU can be completely and absolutely eliminated from the model of POU under test having applied to it the sanitisation method specified by the manufacturer.

In order to allow adequate time for the pathogenic micro-organism to develop a biofilm in each POU, a simulation of normal usage is maintained over a 14 day period. During this time 250 ml of water is drawn from each tap of each POU twice a day (in the morning and in the afternoon). During weekends and public holidays it is acceptable that this regular dispensing is interrupted.

THE PATHOGEN: PSEUDOMONAS AERUGINOSA

The chosen pathogen is *Pseudomonas aeruginosa* for the following reasons:

- Cultivation in water is easy and fast.
- Biofilm is formed.
- It is difficult to eliminate; so if the sanitisation method works to eliminate it, an equivalent result can be expected with other pathogens.
- Detection by a qualified laboratory is easy.
- Although it is a microorganism which is not present in the current European legislation regarding water intended for human consumption, standards of some countries (France: "*Surveillance*")

microbiologique de l'environnement dans les établissements de santé (Air, eaux et surfaces), Comité Technique National des Infections Nosocomiales") are including it as a microorganism of choice due to the formation of biofilm and its pathogenic potential.

ACCEPTABLE STRAINS

At the present time only one strain can be used, as with other strains tested to date, adequate biofilm growth did not occur within 2 weeks. The acceptable strain is:

- Nutrient Agar from Laboratorio Dr Oliver Rodés (LDOR), S.A. of El Prat de Llobregat in Spain, wild strain Collection SS40. (See report 19.5.05)

UNACCEPTABLE STRAINS

The following strains are NOT acceptable:

- Lenticule discs from the Health Protection Agency in Newcastle, UK NCTC10662 - Inadequate bio-film development (See report 14.12.05)
- Bio reference pastilles from the Institute Pasteur de Lille in France ATCC 9027 (CIP82118) - Inadequate biofilm development (See report 30.6.06)
- DIN norm strain ATCC 27853 from DIN norm 19636 (ref: water softeners) - Inadequate biofilm development (See report 26.7.06)

A) WATER TO BE USED

a) Best biofilm development results were obtained by LDOR with a mineral water with more than 90mg of Calcium per litre. This specification is strongly recommended.

b) In order to represent the most challenging conditions, and also to have a standard water which makes the tests comparable, it is recommended that commercially available un-ozonated bottled water with a calcium content in excess of 90mg/l, a minimum TDS (total dissolved solids) and in excess of 150 mg/l and a Langelier Index (L.I.) $\geq +0.5$ at 20°C is used for the tests.

c) Before undertaking any tests, an analysis of the water to be used should be submitted to the EBWA Evaluation Subcommittee for their approval.

NOTE: Water with residual traces of disinfectant (as ozone, chlorine, and others...) it is NOT acceptable.

B) POU TO BE TESTED

a) Three (3) of each model of Cold only, or Cook & Cold POU supplied by the manufacturer. Only cook and cold water systems will be considered as a possible test.

b) For Cook & Hot POU, and Cold & Hot POU, it has been demonstrated that hot water systems that reach $\geq 50^\circ\text{C}$ are able to remove *Pseudomonas aeruginosa* contamination due to high temperatures and not because of the sanitisation procedure.

c) POU of different body types but identical water contact surfaces are classed as of the same model for these purposes.

d) POU treatments do not have to be in place or switched on.

C) TESTING FACILITY

In order to be acceptable to the EBWA, laboratories to be used must be

a) accredited to UNE-EN ISO/IEC 17025

b) able to demonstrate an ability to undertake the test work required in the following areas:

i) Technical ability and experience.

ii) Adequate space to store and test the numbers of POU and bottles of water needed for the trials.

iii) A test facility in Europe. If the facility is outside Europe, the laboratory must be approved by the EBWA Protocol Results Evaluation Sub-committee before testing begins.

c) accredited to do testing of *Pseudomonas aeruginosa* in water by a National or international body:

(e.g. NATA (Australia), BMWA (Austria), BELTEST (Belgium), INMETRO (Brazil), HKAS (China), CAI (Czech Republic), DANAK (Denmark), EAK (Estonia), FINAS (Finland), COFRAC (France), DACH or DAP, or DATech (Germany), ESYD (Greece), INAB (Ireland), ISRAC (Israel), SINAL (Italy), LATAK (Latvia), LA (Lithuania), RVA (Netherlands), LANZ (New Zealand, NA (Norway), PCA (Poland), IPAC (Portugal), RENAR (Romania), SAC/spring (Singapore), SNAS (Slovakia), SA (Slovenia), SANAS (South Africa), ENAC (Spain), SWEDAC (Sweden), SAS (Switzerland), TURKAK (Turkey), UKAS (United Kingdom) and A2LA (USA)).

D) STORAGE OF WATER

- a) Bottled water used throughout the test period should be from the same source and supplier with no variability other than bottling date or production batch codes.
- b) Identical batch codes should be used simultaneously on all POU under test and control.
- c) The water should be stored in a cool (15°C-25°C) dark place, away from polluting or contaminating substances.

E) SANITISATION

- a) This must be undertaken in accordance with the methodology and materials supplied by the POU or device manufacturer.
- b) Staff undertaking sanitisation must either be trained by a qualified representative of the POU manufacturer or the manufacturer must provide trained staff to undertake the sanitisation at the appointed time.
- c) The third party testing facility representative must supervise the entire sanitisation operation.
- d) All replacement water contact components used for sanitisation shall be supplied in sealed packs and only handled with clean disposable gloves by the person qualified to execute the sanitisation.

F) SUMMARY OF REQUIREMENTS

- a) 3 POU of each model to be tested.
- b) 5 Gallon bottles (18,9L) of mineral water (10 bottles approximately).
- c) 2 tanks, with 100 litres of volume per tank. (Tank #1 and Tank #2).
- d) 2 boost pumps for liquids. (Pump #1 and Pump#2).
- e) Polypropylene connectors, fittings, reducers, valves, etc. (Ex: John Guest®).
- f) Disposable tubes to make a water circuit.

G) TESTING

The test procedure module has 5 steps, described in more detail below:

Step 1: Fill tank #1 with mineral water contaminated with *Pseudomonas aeruginosa*.

Step 2: Connect the 3 POU to the tank and simulate 14 days of field use.

Step 3: Sanitise the 3 POU with a method specified by manufacturer.

Step 4: Fill tank #2 with mineral water free of *Pseudomonas aeruginosa*. Plug into the water system a new water circuit free of *Pseudomonas aeruginosa*.

Step 5: Test for the absence of *Pseudomonas aeruginosa* in 250 ml of samples of water drawn from each POU tap.

STEP 1

Preparing tank #1 and pump #1:

1. Fill the tank #1 with bottles of mineral water. Necessary volume depends on POU internal tanks and length of tubes circuit.
2. Inoculate *Pseudomonas aeruginosa* into the tank with 10^4 to 10^5 cfu, to reach a homogenised concentration in the tank ≥ 100 cfu/250 mL. The concentration of contamination (≥ 100 cfu /250mL) must be submitted by the laboratory in order to compare the evolution of the contamination.

STEP 2

Contaminating POU:

1. Interconnect POU (with no carbon filters and treatments switched off) to tank #1 and pump #1, with polypropylene pieces and compatible tubes.
2. In order to ensure that the contaminated water is in contact with all POU internal components, 250 mL of contaminated water should be drawn off from each tap.
3. The POU are NOT to be plugged into the electrical supply because the bacteria best develops at room temperature (20 to 30°C). If the taps require that the electrical supply is switched on to allow them to open, do this for only the minimum time required to open and draw-off water and then unplug the POU from the electrical supply.
4. After a 3 day period, a *Pseudomonas aeruginosa* count performed on water samples drawn off from the cold tap of each of the 3 POU. If necessary, the machine can be plugged into the electrical supply long enough to allow for this.
5. The level of contamination of each water sample after 3 days must be at a minimum 100 cfu / 250 mL. If that level has not been attained, the POU has to be re-contaminated (go back to Step 1.2 and re-inoculate bacteria into the tank).
6. Simulation of normal use is maintained for the period of 14 days by drawing off 250 mL samples of water from each tap of each POU twice a day (in the morning and in the afternoon). During weekends and public holidays regular dispensing may be interrupted.
7. On Day 14, a *Pseudomonas aeruginosa* count should be undertaken on water drawn from each tap of each of the 3 POU.
8. The level of contamination measured from samples taken from each tap after the 14 day period must be at least ≥ 100 cfu / 250 mL. This ensures the *Pseudomonas aeruginosa* is still vigorous. If the count reaches this level, proceed to Step 3. If the level of contamination after 14 days on a sample taken from any POU is lower than the inoculation level, it will be necessary to go back to Step 1.2 and re-inoculate bacteria into the tank.

STEP 3

Sanitising As Specified by Manufacturer

1. Undertake the sanitisation method specified by the manufacturer of the POU. This sanitisation method must be the one specified in the manufacturer's manual supplied with the POU when distributed to users or the method officially notified by the manufacturer to its clients.
2. The sanitisation method should specify which POU models (made by the same manufacturer) have been tested with, and therefore use, that particular sanitisation method.
3. Laboratory staff undertaking sanitisation must either be trained by a qualified representative of the POU manufacturer or the manufacturer must provide trained staff to undertake the sanitisation at the appointed time. Should the manufacturer's staff undertake sanitisation then qualified laboratory staff must supervise the operation.

4. In case of any difference in the methodology of sanitisation between the written manufacturer's manual and the procedure actually applied, the manufacturer's manual must be modified accordingly, and a new manual distributed to all clients of the manufacturer.
5. Manufacturer's sanitisation manual must include date of issue and number of version.

STEP 4

Preparing tank #2, pump #2, and new water circuit.

1. Fill the tank #2 with bottles of mineral water free of *Pseudomonas aeruginosa*. Necessary volume depends on POU internal tanks and length of tubes circuit.
2. Interconnect POU, tank #2 and pump #2, with new polypropylene pieces and compatible tubes, free of *Pseudomonas aeruginosa*.
3. Take water samples from the tank #2 and pump #2 to check the absence of *Pseudomonas aeruginosa* in 250 mL. The tests results must be less than quantification limit/250ml.

STEP 5

Test for the absence of *Pseudomonas aeruginosa*

1. Immediately after re-filling the POU with mineral water free of *Pseudomonas aeruginosa*, water samples of 250 ml should be drawn from each tap of the POU and the absence of *Pseudomonas aeruginosa* (t'0) verified. The test result must be less than quantification limit/250ml.
2. Testing of samples drawn from the POU should continue for a period of 14 days, in the same manner as in Step 2. Water samples must remain free of *Pseudomonas aeruginosa*.

H) RESULTS EXPECTED MODULE THREE-B - THE CHALLENGE TEST FOR POU

A pass is registered only when 12 results from each POU under test are less than quantification limit/250ml on each tap at t'0 and t'14 .

WHERE t' means Time & t'0 and t'14 mean Day One and Day Fourteen after the sanitisation.

t'0 and t'14 \geq quantification limit/250ml - FAIL

t'0 and t'14 < quantification limit/250ml – PASS

NOTES

Note 1: The test result will be valid for each model of POU with identical water contact surfaces as the ones tested. "Identical models" is defined here as, "two different looking POU whose surface materials and design of all parts in contact with water are the same".

Note 2: The test result will be valid only for the sanitising method tested for Module Three-B. Each new sanitising method would then have to be fully tested to be certified in the Module.

Note 3: The result of the level of contamination (≥ 100 cfu /250ml) must be given by the laboratory in exact counts in order to compare the evolution of contamination. (≥ 100 cfu /250m is not acceptable because it could be 10000000 or 101)

Note 4: Manufacturers, at their own discretion, may extend the test period in Step 5 from 14 to 21 days if they wish to demonstrate extended performance of their POU and/or sanitisation method.

I) SUBMISSION OF RESULTS

Results from all test POU with full details of the methodology used should be submitted to the EBWA Secretariat accompanied by full details and relevant accreditation(s) of the laboratory used. This information

will only be examined by members of the EBWA Protocol Results Evaluation Sub-committee and will be kept strictly confidential.

March 2009

Annex VI

Standard Methodology for the examination of dispensed water of Point of Use & Point of Entry Water Coolers installed inside buildings.

The following standard methodology was developed by the Watercoolers Europe Standards Committee in October 2010 and approved by the General Managers Associations Meeting during the WE Trade Fair and Convention held in Odessa (Ukraine) on 19th to 22nd of September of 2011.

It is not objective of this essay to certify neither filters nor treatment that could be inside of PoU/PE. These certificates are complementary to this essay. It is a proposal therefore a starting point to help the sector to comply with existing EU legislation applicable to water for human consumption quality.

The essay that follows is not mandatory in all states of the European Union. It is an essay that provides information to WE members how is in reality the water dispensed by their PoU and it is designed to improve their water treatment equipment since it can detect abnormalities of manufacturing equipment that can be solved easily if the tests indicated at this standard are performed. However, this standard methodology is not mandatory for our members at the date of issue of this CoP.

**STANDARD METHODOLOGY
FOR THE EXAMINATION OF
DISPENSED WATER OF
Point of Use & Point of Entry
WATER COOLERS
INSTALLED INSIDE BUILDINGS
PROTOCOL 4**



TABLE OF CONTENTS

INTRODUCTION	37
SCOPE	37
APPLICABLE EQUIPMENTS	38
DEVICE SUPPLY	38
LEGAL REQUIREMENTS	38
STANDARD REFERENCES FOR PROTOCOL 4	39
METHODOLOGY	41
MIGRATION CONTROL	41
CHEMICAL & MICROBIOLOGICAL CONTROL	42
Protocol 4.1 FOR POU CONNECTED TO MAIN WITH NO ACCUMULATION TANK	43
Protocol 4.2 FOR POU NOT CONNECTED TO MAIN SUPPLY	45
Protocol 4.3 FOR POU CONNECTED TO MAIN WITH ACCUMULATION TANK.	47
Protocol 4.4 FOR PE EQUIPMENTS THAT COULD BE REGENERATED	49
TESTING FACILITY	51
BIBLIOGRAPHY	51

ANNEX A		52
	SAMPLING PROTOCOL 4	
ANNEX B	PASS CRITERIA FOR CHEMICAL & MICROBIOLOGICAL PARAMETERS	53
ANNEX B.1	PASS CRITERIA FOR CHEMICAL PARAMETERS	53
ANNEX B.2	PASS CRITERIA FOR MICROBIOLOGICAL PARAMETERS	55
ANNEX C	OPERATIONAL SPECIFICATION STANDARDS FOR WATER TREATMENT EQUIPMENT DEVELOPED BY CEN/TC 164/WG 13	56
ANNEX D	MATERIALS & PRODUCTS ALLOWED TO BE IN CONTACT WITH WATER FOR HUMAN CONSUMPTION	57

INTRODUCTION

Directive 98/83/EC establishing the health criteria of the quality of water for human consumption, provides in

“Article 4 General obligations

1. Without prejudice to their obligations under other Community provisions, Member States shall take the measures necessary to ensure that water intended for human consumption is wholesome and clean. For the purposes of the minimum requirements of this Directive, water intended for human consumption shall be wholesome and clean if it:

(a) is free from any micro-organisms and parasites and from any substances which, in numbers or concentrations, constitute a potential danger to human health, and

(b) meets the minimum requirements set out in Annex I, Parts A and B;...”

“Article 6 Point of compliance

1. The parametric values set in accordance with Article 5 shall be complied with:

(a) in the case of water supplied from a distribution network, at the point, within premises or an establishment, at which it emerges from the taps that are normally used for human consumption;...”

“Article 10 Quality assurance of treatment, equipment and materials

Member States shall take all measures necessary to ensure that no substances or materials for new installations used in the preparation or distribution of water intended for human consumption or impurities associated with such substances or materials for new installations remain in water intended for human consumption in concentrations higher than is necessary for the purpose of their use and do not, either directly or indirectly, reduce the protection of human health provided for in this Directive;...”

The existing European standards on water treatment equipment, specify the quality requirements specified in reference to the operation of the equipment but do not include testing to determine that its use do not transfer to water to be consumed, substances, germs or undesirable or harmful properties to health.

The proposed essay in the methodology describes the basic criteria of aptitude of Point of Use and Point of Entry water treatment devices in Article 10 of Directive 98/83/EC and other complementary legal texts that ensures that water intended for human consumption is wholesome and clean.

For the development of this essay, tests on different equipments have been tested in authorized laboratory to verify compliance with the requirements of the present Standard.

SCOPE

This essay establishes the criteria for determining if a water treatment equipment can be used without conveying to the water for human consumption substances, microorganisms or undesirable properties or detrimental to health.

This essay does not consider the performance specifications of water treatment equipment because they are listed in the Standards developed by CEN TC-164, WG-13 (see Annex C).

It is not objective of this essay to certify neither filters nor treatment that could be inside of PoU/PE. These certificates are complementary to this essay. It is a proposal therefore a starting point to help the sector to comply with existing EU legislation applicable to water for human consumption quality.

The essay that follows is not mandatory in all states of the European Union. It is an essay that provides information to WE members how is in reality the water dispensed by their PoU and it is designed to improve the water treatment equipment since it can detect abnormalities of manufacturing equipment that can be solved easily if the tests indicated at this standard are performed.

APPLICABLE EQUIPMENTS:

This essay applies to any kind of water cooler devices:

- PoU connected to water supply network with accumulation tank (e.g. PoU's with any kind of water reservoirs).
- PoU connected to water supply network without accumulation tank (e.g. PE with no reservoirs).
- PoU no-connected to water supply network (e.g. jugs).
- PE equipment that can be regenerated (e.g. equipments with resins or softeners).

DEVICE SUPPLY:

All necessary information for installation, commissioning, operation and maintenance (stressing the importance of maintenance) shall be provided with the equipment so that it can be confirmed that the equipment is appropriate for the application, location, resources available, consumable requirements, etc.

Maintenance and repair are presumed to be specialist activities and their availability shall be part of the product documentation.

As far as the repair is concerned, it shall be specified, whether the product requires disposal in case of failure/exhaustion (including instruction for disposal) or whether it can be restored almost to the original performance, if properly repaired.

All the documentation (e.g. label, logbook, instruction manual) provided with the device shall be presented in the official language(s) of the country in which the device is purchased.

Where the device is purchased to include the service of installation and commissioning, this shall be clearly stated in the supply contract and the activities shall be conducted in accordance with the requirements of this European Guideline.

LEGAL REQUIREMENTS:

The equipment to perform the test must have a statement meet the prerequisites as described in Annex D. materials & products allowed to be in contact with water for human consumption

Pass/Fail criteria is according to the current legislation:

- For chemical and microbiological control:
 - *Directive 98/83/EC of 3 November 1998 on the quality of water intended for human consumption.*
- For plastic migration control:
 - *Regulation (EU) No 10/2011 of 14 January on plastic materials and articles intended to come into contact with food.*

STANDARD REFERENCES FOR PROTOCOL 4:

The documents listed below are essential to the implementation of this standard. Only applies editing documents with publication date. On the other hand, applies the latest edition of those documents that are referenced undated.

In the bibliography and in Annex C, for information purposes other normative references are cited.

UNE 19049-1: Stainless steel tubes for interior instalations of hot/cold water. Part 1: Tubes.

ISO 16422: Pipes and joints made of oriented unplasticized poly(vinyl chloride) (PVC-O) for the conveyance of water under pressure – Specifications.

EN 545 Ductile iron pipes, fittings, accessories and their joints for water pipelines - Requirements and test methods.

EN 681-1: Elastomeric seals for joints in water and drainage applications. Part 1 Vulcanised rubber seals.

EN 681-1/AC: Elastomeric seals for joints in water and drainage applications. Part 1 Vulcanised rubber seals.

EN 681-1/A1: Elastomeric seals for joints in water and drainage applications. Part 1 Vulcanised rubber seals.

EN 681-1/A2: Elastomeric seals for joints in water and drainage applications. Part 1 Vulcanised rubber seals.

EN 681-1/A3: Elastomeric seals for joints in water and drainage applications. Part 1 Vulcanised rubber seals.

EN 681-2: Elastomeric seals. Material requirements for pipe joint seals used in water and drainage applications. Part 2. Thermoplastic.

EN 681-2/A1: Elastomeric seals. Material requirements for pipe joint seals used in water and drainage applications. Part 2. Thermoplastic elastomers.

EN 681-2/A2: Elastomeric seals. Material requirements for pipe joint seals used in water and drainage applications. Part 2. Thermoplastic elastomers.

EN 681-3: Elastomeric seals —Materials requirements for pipe joint seals used in water and drainage applications — Part 3: Cellular materials of vulcanized rubber.

EN 681-3/A1: Elastomeric seals —Materials requirements for pipe joint seals used in water and drainage applications — Part 3: Cellular materials of vulcanized rubber.

EN 681-3/A2: Elastomeric seals —Materials requirements for pipe joint seals used in water and drainage applications — Part 3: Cellular materials of vulcanized rubber.

EN 681-4: Elastomeric seals - Material requirements for pipe joint seals used in water and drainage applications - Part 4: Cast polyurethane sealing elements.

EN 681-4/A1: Elastomeric seals - Material requirements for pipe joint seals used in water and drainage applications - Part 4: Cast polyurethane sealing elements.

EN 681-4/A2: Elastomeric seals - Material requirements for pipe joint seals used in water and drainage applications - Part 4: Cast polyurethane sealing elements.

EN 1057: Copper and copper alloys. Seamless, round copper tubes for water and gas in sanitary and heating applications.

EN 10255+A1: Non-alloy steel tubes suitable for welding and threading — Technical delivery conditions.

EN 12201-1: Plastics piping systems for water supply, and for drainage and sewerage under pressure — Polyethylene (PE). Part 1: General.

EN 12201-2: Plastic piping systems for water supply. Polyethylene (PE). Part 2: Pipes.

EN 12201-3: Plastic piping systems for water supply. Polyethylene (PE). Part 3: Fittings.

EN 12201-4: Plastic piping systems for water supply. Polyethylene (PE). Part 4: Valves.

EN 12499: Internal cathodic protection of metal structures.

EN 15161: Water conditioning equipment inside buildings — Installation, operation, maintenance and repair.

EN ISO 1452-1: Plastics piping systems for water supply and for buried and above-ground drainage and sewerage under pressure — Unplasticized poly(vinyl chloride) (PVC-U). Part 1: General (ISO 1452-1:2009).

EN ISO 1452-2: Plastics piping systems for water supply and for buried and above-ground drainage and sewerage under pressure — Unplasticized poly(vinyl chloride) (PVC-U). Part 2: Pipes (ISO 1452-2:2009).

EN ISO 1452-3: Plastics piping systems for water supply and for buried and above-ground drainage and sewerage under pressure — Unplasticized poly(vinyl chloride) (PVC-U). Part 3: Fittings (ISO 1452-3:2009).

EN ISO 15874-1: Plastics piping systems for hot and cold water installations — Polypropylene (PP). Part 1: General (ISO 15874-1:2003)

EN ISO 15874-2: Plastics piping systems for hot and cold water installations — Polypropylene (PP). Part 2: Pipes. (ISO 15874-2:2003)

EN ISO 15874-3: Plastics piping systems for hot and cold water installations — Polypropylene (PP). Part 3: Fittings. (ISO 15874-3:2003)

ISO 15875-1: Plastics piping systems for hot and cold water installations -- Crosslinked polyethylene (PE-X) -- Part 1: Generalities (ISO 15875-1:2003)

ISO 15875-2: Plastics piping systems for hot and cold water installations -- Crosslinked polyethylene (PE-X) -- Part 2: Pipes (ISO 15875-2:2003)

ISO 15875-3: Plastics piping systems for hot and cold water installations -- Crosslinked polyethylene (PE-X) -- Part 3: Fittings. (ISO 15875-3:2003)

EN ISO 15876-1: Plastics piping systems for hot and cold water installations -- Polybutylene (PB) -- Part 1: Generalities. (ISO 15876-1:2003).

EN ISO 15876-2: Plastics piping systems for hot and cold water installations -- Polybutylene (PB) -- Part 2: Pipes. (ISO 15876-2:2003).

EN ISO 15876-3: Plastics piping systems for hot and cold water installations -- Polybutylene (PB) -- Part 3: Fittings. (ISO 15876-3:2003).

EN ISO 15877-1: Plastics piping systems for hot and cold water installations — Chlorinated poly(vinyl chloride) (PVC-C). Part 1: Generalities (ISO 15877-1:2009)

EN ISO 15877-2: Plastics piping systems for hot and cold water installations — Chlorinated poly(vinyl chloride). (PVC-C). Part 2: Pipes. (ISO 15877-2:2009)

EN ISO 15877-3: Plastics piping systems for hot and cold water installations — Chlorinated poly(vinyl chloride). (PVC-C). Part 3: Fittings. (ISO 15877-3:2009)

EN ISO 21003-1: Multilayer piping systems for hot and cold water installations inside buildings.

EN ISO 22391-1: Plastics piping systems for hot and cold water installations — Polyethylene of raised temperature resistance (PE-RT). Part 1: Generalities. (ISO 22391-1:2009)

EN ISO 22391-2: Plastics piping systems for hot and cold water installations — Polyethylene of raised temperature resistance (PE-RT). Part 2: Pipes. (ISO 22391-2:2009)

EN ISO 22391-3: Plastics piping systems for hot and cold water installations — Polyethylene of raised temperature resistance (PE-RT). Part 3: Fittings. (ISO 22391-3:2009)

EN ISO 22391-5: Plastics piping systems for hot and cold water installations — Polyethylene of raised temperature resistance (PE-RT). Part 5: Fitness for purpose of the system. (ISO 22391-5:2009)

METHODOLOGY

The basis of the essay is essentially to compare the water tests results that come from the distribution network (that reaches just before the devices) with the water tests results that come from water dispensed by the PoU/PE.

The essay consists in three kinds of tests:

- MIGRATION CONTROL Tests of possible migration of plastic materials in contact with water included on *Regulation (EU) No 10/2011*

- CHEMICAL CONTROL Tests of migration of other chemical in contact with water included on *Directive 98/83/EC*.

- MICROBIOLOGICAL CONTROL Tests of possible abnormal growing of microorganisms included on *Directive 98/83/EC*

In order to make the test as realistic as possible, a water installation as described below must be installed in facilities where analysis is performed:

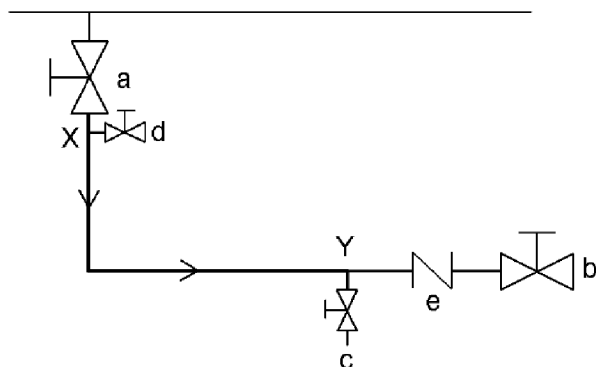

a. Valve to control the entrance of water.

b. Valve where the equipment is connected.

c. Valve where the blank samples are extracted.

- d. Drain faucet.
- e. Anti-return valve.

MIGRATION CONTROL

Applicable legislation:	Regulation (EU) No 10/2011.
Duration:	9 days.
Volume sample:	all volume contained in the PoU/PE.
Number of PoU and PE needed:	1 PoU/PE
Blank sample:	extracted from "c".
PoU and PE test sample:	extracted from the equipment exit.
Pass/Fail criteria:	pass criteria correspond to obtain a value of the identified compound in the water coming from the PoU/PE equipment interior below the legislated values.

Procedure of the migration test

1. Blank sample is extracted from main water supply (from "c") before starting the incubation periods of migration test.
2. PoU equipment is filled with main water supply and it remains for 3 days at 20 °C
3. Point 2 is repeated for a total of 3 times.
4. After 3rd incubation period, the water is extracted and analysed
5. Pass/fail criteria is obtained from the comparison of the difference between the 3rd incubation period and the blank sample.

Pass criteria correspond to obtain an amount of migrated compound under the legislation value (Regulation (EU) No 10/2011)

Fail criteria correspond to obtain an amount of migrated compound over the legislation value (Regulation (EU) No 10/2011)

CHEMICAL & MICROBIOLOGICAL CONTROL

Applicable legislation:	Directive 98/83/EC.
Duration:	5 days.
Volume sample:	5 L.
Number of PoU and PE needed:	1, except for PoU with accumulation tank and PoU no-connected to water supply network (jugs). For these cases it is necessary a sufficient number of equipments to obtain 5 L of water sample.

Examples:

Volume of treated water that is inside the equipment	Number of equipments needed for the essay
--	---

1L	5
2L	3
3L	2
4L	2
5L	1

- Blank sample:** extracted from “c”.
- PoU and PE test sample:** extracted from the longest loop device tap.
- Pass/Fail criteria:** Pass criteria correspond to obtain a parameter value below the maximum increase comparing blank (coming from “c”) and sample water coming from the PoU/PE.

Procedure of the chemical and microbiological analysis

The procedures described below are different depending on the type of POU you want to test. See Annex A and B, to follow the Procedures and to know the parameters to be tested. We can distinguish three different protocols depending on the PoU to be tested in the essay:

- Protocol 4.1 PoU connected to main with NO accumulation tank. (eg. Carbon Filters or Reverse osmosis with no water reservoir)
- Protocol 4.2 PoU NOT connected to main supply (eg. Jugs)
- Protocol 4.3 PoU connected to main supply with accumulation tank (eg. Reverse Osmosis or Carbon filter PoU with water reservoirs)
- Protocol 4.4 PE equipments that could be regenerated (eg. Softeners)

PROTOCOL 4.1 For POU CONNECTED TO MAIN WITH NO ACCUMULATION TANK

1. 6 times a day for 3 days, drain water for 10 minutes by the equipment to be tested.
2. Blank sample is taken from “c point” water main supply after the eighteenth drainage. A Chemical and microbiological test following Directive 98/83/EC (*“Annex I. Part B Chemical parameters & Part C. Indicator parameters”* for chemical parameters and *“Annex I. Part A Microbiological parameters and Part C. Indicator parameters”* for microbiological parameters) are done obtaining chemical results **Ch1** and microbiological results **M1**.
3. After 24h having the water inside the equipment, a second blank sample is extracted from “c point” water main supply. A microbiological test following Directive 98/83/EC (*Annex I. Part A Microbiological parameters and Part C. Indicator parameters”*) is done obtaining microbiological results **M2**.
4. Immediately after taking the sample described in point 3, drain half of the volume of water that is inside of the equipment/s.
5. Take a sample from the equipment after point 4. A Chemical and microbiological test of treated water following Directive 98/83/EC (*“Annex I. Part B Chemical parameters & Part C. Indicator parameters”* for chemical parameters and *“Annex I. Part A Microbiological parameters and Part C. Indicator parameters”* for microbiological parameters) are done obtaining chemical results **Ch2ab** and microbiological results **M3**.
6. Compare Microbiological results before and after PoU (M2 with M3 water samples results)

7. Compare Chemical results before and after PoU (Ch1 with Ch2ab)

8. Pass/fail criteria is obtained from the comparison with Directive 98/83/EC. See Annex B.

Pass criteria correspond to obtain a parameter value under the maximum increase between blank and sample water described in UNE 149101

Fail criteria correspond to obtain a parameter value over the maximum increase between blank and sample water described in UNE 149101

Sampling Protocol 4.1

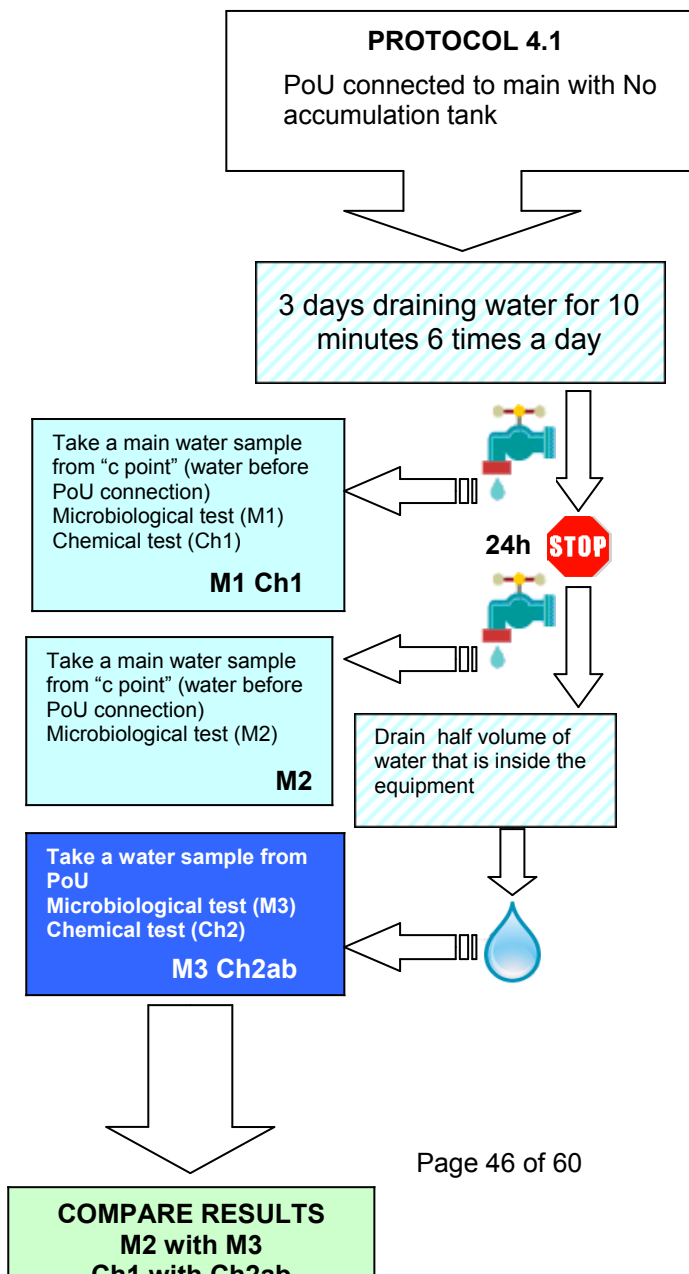

PROTOCOL 4.2 For POU NOT CONNECTED TO MAIN SUPPLY

1. Once a day for 3 days, drain 2 times the total volume that is inside the equipment to be tested.
2. Blank sample is taken from “c point” water main supply after the third drainage. A Chemical and microbiological test following Directive 98/83/EC (*“Annex I. Part B Chemical parameters & Part C. Indicator parameters”* for chemical parameters and *“Annex I. Part A Microbiological parameters and Part C. Indicator parameters”* for microbiological parameters) are done obtaining chemical results **Ch1** and microbiological results **M1**.
3. After 24h having the water inside the equipment, a second blank sample is extracted from “c point” water main supply. A microbiological test following Directive 98/83/EC (*Annex I. Part A Microbiological parameters and microbiological parameters of Part C. Indicator parameters”*) is done obtaining microbiological results **M2**.
4. Immediately after taking the sample described in point 3, take a sample from the equipment. A Chemical and microbiological test of treated water following *Directive 98/83/EC (“Annex I. Part B Chemical parameters & Part C. Indicator parameters”* for chemical parameters and *“Annex I. Part A Microbiological parameters and Part C. Indicator parameters”* for microbiological parameters) are done obtaining chemical results **Ch2ab** and microbiological results **M3**.
5. Compare Microbiological results before and after PoU (M2 with M3 water samples results)
6. Compare Chemical results before and after PoU (Ch1 with Ch2ab)
7. Pass/fail criteria is obtained from the comparison with Directive 98/83/EC. See Annex B.

Pass criteria correspond to obtain a parameter value under the maximum increase between blank and sample water described in UNE 149101

Fail criteria correspond to obtain a parameter value over the maximum increase between blank and sample water described in UNE 149101

Sampling Protocol 4.2

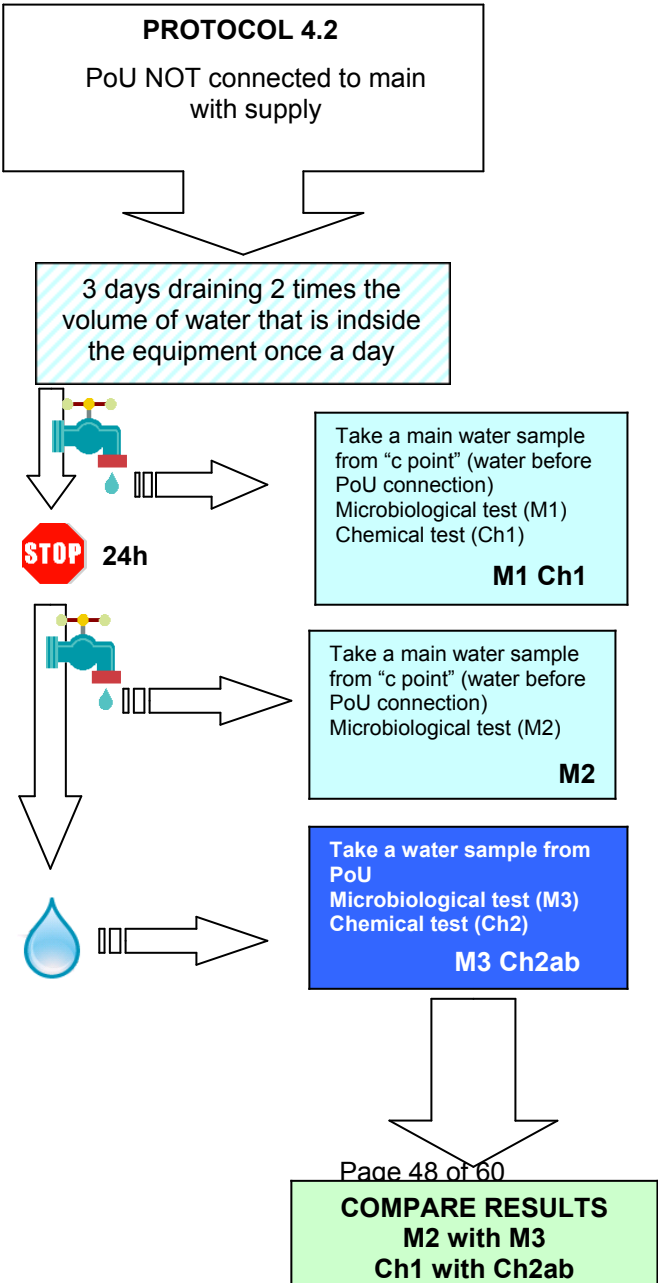

PROTOCOL 4.3 For POU CONNECTED TO MAIN SUPPLY WITH ACCUMULATION TANK

1. 2 times a day for 3 days, drain 1 time the total volume that is inside the equipment to be tested.
2. Blank sample is taken from “c point” water main supply after the sixth drainage. A Chemical and microbiological test following Directive 98/83/EC (*“Annex I. Part B Chemical parameters & Part C. Indicator parameters”* for chemical parameters and *“Annex I. Part A Microbiological parameters and Part C. Indicator parameters”* for microbiological parameters) are done obtaining chemical results **Ch1** and microbiological results **M1**.
3. After 24h having the water inside the equipment, a second blank sample is extracted from “c point” water main supply. A microbiological test following Directive 98/83/EC (*Annex I. Part A Microbiological parameters and microbiological parameters of Part C. Indicator parameters”*) is done obtaining microbiological results **M2**.
4. Immediately after taking the sample described in point 3, drain half of the volume of water that is inside of the equipment/s.
5. Take a sample from the equipment after point 4. A Chemical and microbiological test of treated water following Directive 98/83/EC (*“Annex I. Part B Chemical parameters & Part C. Indicator parameters”* for chemical parameters and *“Annex I. Part A Microbiological parameters and Part C. Indicator parameters”* for microbiological parameters) are done obtaining chemical results **Ch2ab** and microbiological results **M3**.
6. Compare Microbiological results before and after PoU (M2 with M3 water samples results)
7. Compare Chemical results before and after PoU (Ch1 with Ch2ab)
8. Pass/fail criteria is obtained from the comparison with Directive 98/83/EC. See Annex B.

Pass criteria correspond to obtain a parameter value under the maximum increase between blank and sample water described in UNE 149101.

Fail criteria correspond to obtain a parameter value over the maximum increase between blank and sample water described in UNE 149101.

Sampling Protocol 4.3

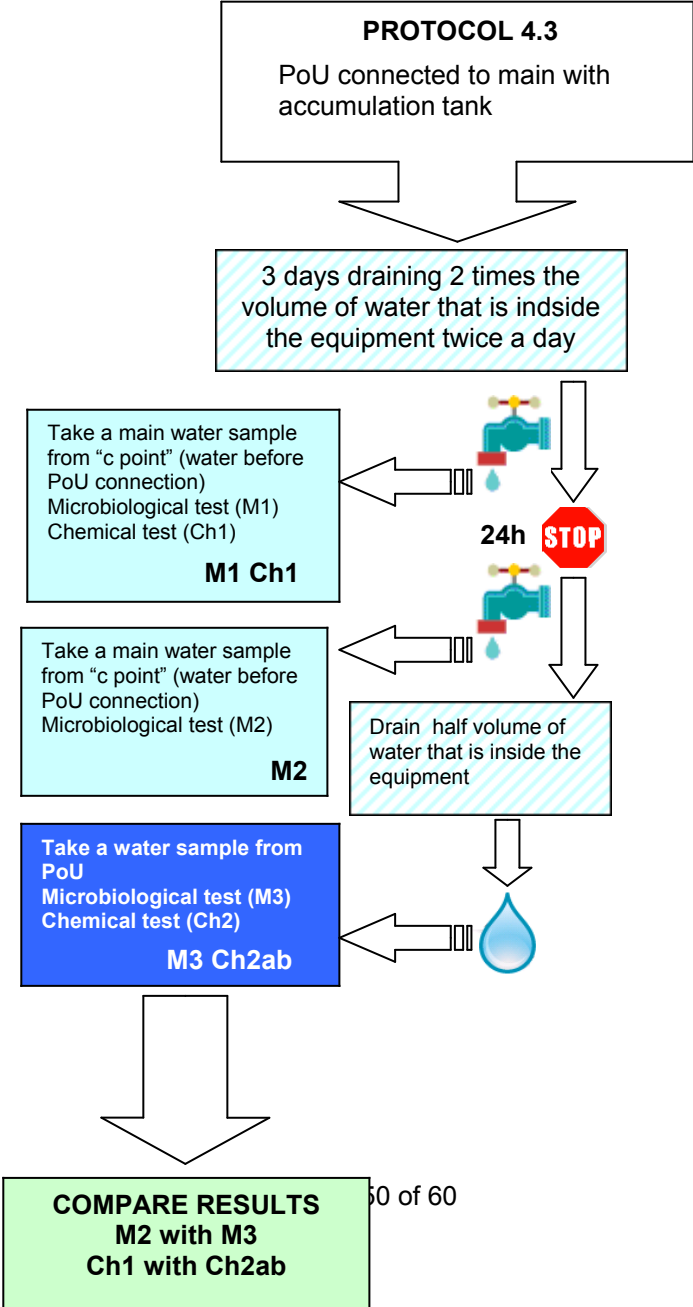

PROTOCOL 4.4 For PE EQUIPMENTS THAT COULD BE REGENERATED

1. Once a day for 3 days, drain 1000L or 5 times the total volume that is inside the equipment (choosing the higher volume) from the equipment to be tested.
2. Blank sample is taken from “c point” water main supply after the third drainage. A Chemical and microbiological test following Directive 98/83/EC (*Annex I. Part B Chemical parameters & Part C. Indicator parameters*) for chemical parameters and *Annex I. Part A Microbiological parameters and Part C. Indicator parameters* for microbiological parameters) are done obtaining chemical results **Ch1** and microbiological results **M1**.
3. After 24h having the water inside the equipment, a second blank sample is extracted from “c point” water main supply. A microbiological test following Directive 98/83/EC (*Annex I. Part A Microbiological parameters and microbiological parameters of Part C. Indicator parameters*) is done obtaining microbiological results **M2**.
4. Immediately after taking the sample described in point 3, drain half of the volume of treated water that is inside of the equipment/s.
5. Take a sample from the equipment after point 4. A Chemical and microbiological test of treated water following *Directive 98/83/EC (Annex I. Part B Chemical parameters.* for chemical parameters and *Annex I. Part A Microbiological parameters and microbiological parameters of Part C. Indicator parameters* for microbiological parameters) are done obtaining chemical results **Ch2a** and microbiological results **M3**.
6. Immediately after taking the samples described in point 5, drain 10 volumes of water of treated water that is inside of the equipment/s.
7. Take a sample from the equipment after point 6. A Chemical and microbiological test of treated water following Directive 98/83/EC (chemical parameters of *Annex I. Part C Indicator parameters.* and *Annex I. Part A Microbiological parameters and microbiological parameters of Part C. Indicator parameters*) is done obtaining chemical results **Ch2b** and microbiological results **M4**.
8. Compare Microbiological results before and after PoU (M2 with M3 and M2 with M4 water samples results)
9. Compare Chemical results before and after PoU (Ch1 with Ch2ab)

10. Pass/fail criteria is obtained from the comparison with Directive 98/83/EC. See Annex B.

Pass criteria correspond to obtain a parameter value under the maximum increase between blank and sample water described in UNE 149101.

Fail criteria correspond to obtain a parameter value over the maximum increase between blank and sample water described in UNE 149101.

Sampling Protocol 4.4

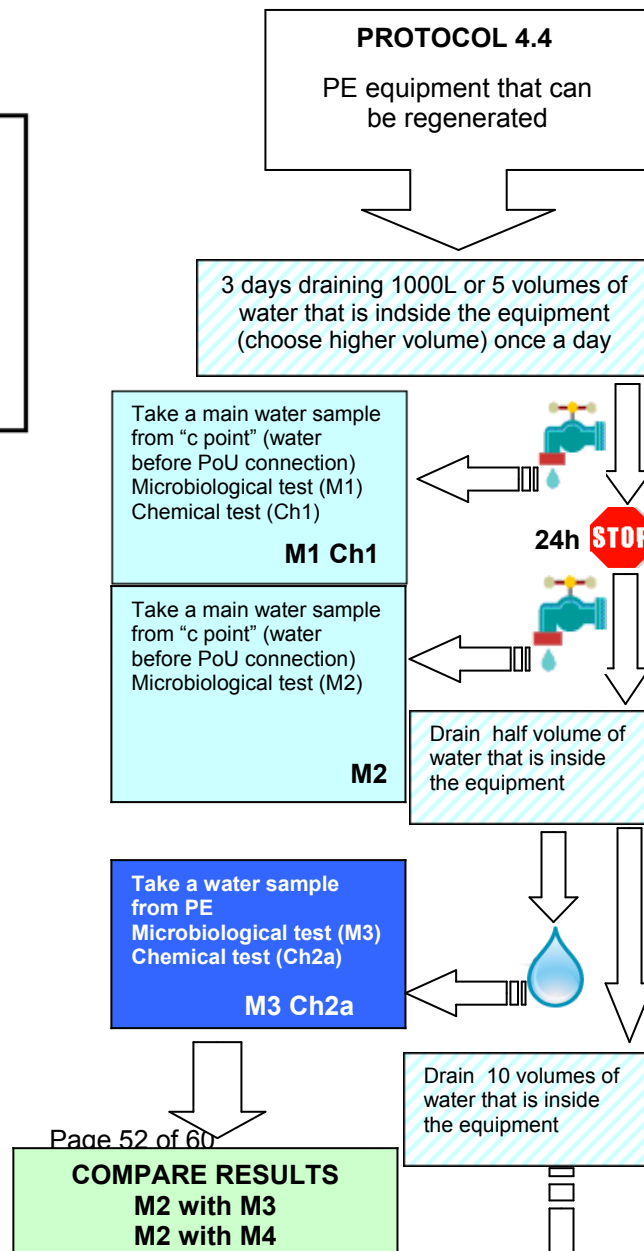
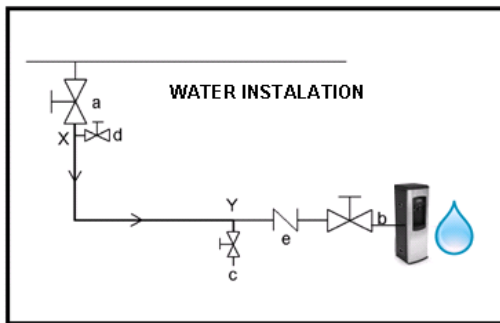

TESTING FACILITY

In order to be acceptable to WE, laboratories to be used must be NAMAS or similarly accredited and able to demonstrate an ability to undertake the test work required in the following areas:

- a) Technical ability and experience.
- b) Adequate space to store and test the number of PoU of water needed for the trials.
- c) A test facility in Europe. If the facility is outside Europe, the laboratory must be approved by the WE Protocol Evaluation Sub-committee before testing begins.
- d) Accredited according to UNE-EN ISO/IEC 17025 by a national or internationally recognised authority to test water for human consumption.

(e.g. NATA (Australia), BMWA (Austria), BELTEST (Belgium), INMETRO (Brazil), HKAS (China), CAI (Czech Republic), DANAK (Denmark), EAK (Estonia), FINAS (Finland), COFRAC (France), DACH or DAP, or DATech (Germany), ESYD (Greece), INAB (Ireland), ISRAC (Israel), SINAL (Italy), LATAK (Latvia), LA (Lithuania), RVA (Netherlands), LANZ (New Zealand, NA (Norway), PCA (Poland), IPAC (Portugal), RENAR (Romania), SAC/spring (Singapore), NAS (Slovakia), SA (Slovenia), SANAS (South Africa), ENAC (Spain), SWEDAC (Sweden), SAS (Switzerland), TURKAK (Turkey), UKAS (United Kingdom) and A2LA (USA)).

BIBLIOGRAPHY:

- *Directive 98/83/EC of 3 November 1998 on the quality of water intended for human consumption.*
- *Regulation (EU) No 10/2011 of 14 January on plastic materials and articles intended to come into contact with food.*
- *Regulation (EU) No 1907/2006 of 18 concerning the Registration, Evaluation, Authorisation and Restriction of Chemicals (REACH), establishing a European Chemicals Agency, amending Directive 1999/45/EC and repealing Regulation (EEC) No 793/93 and Regulation (EC) No 1488/94 as well as Directive 76/769/EEC and Commission Directives 91/155/EEC, 93/67/EEC, 93/105/EC and 2000/21/EC*
- *EN ISO/IEC 17025. General requirements for the competence of testing and calibration laboratories.*

- Directive 89/106/EEC of 21 December 1988 on the approximation of laws, regulations and administrative provisions of the Member States relating to construction products

- Directive 2008/39/EC of 6 March 2008 amending Directive 2002/72/EC relating to plastic materials and articles intended to come into contact with food.

- UNE 149101:2011 Water conditioning equipment inside buildings. Basic criteria for suitability of equipment used in the treatment of water for human consumption inside buildings.

- Desalination Guide: technical aspects and health in the production of water for human consumption. Reports, Studies and Research 2009. Ministry of Health and Social Policy. Government of Spain.

- UNE 112076 Corrosion prevention in water systems.

- UNE 149101 Water conditioning equipment inside buildings. Basic aptitude criteria of equipment used in the treatment of water for human consumption inside buildings.

ANNEX A. Sampling Protocol 4

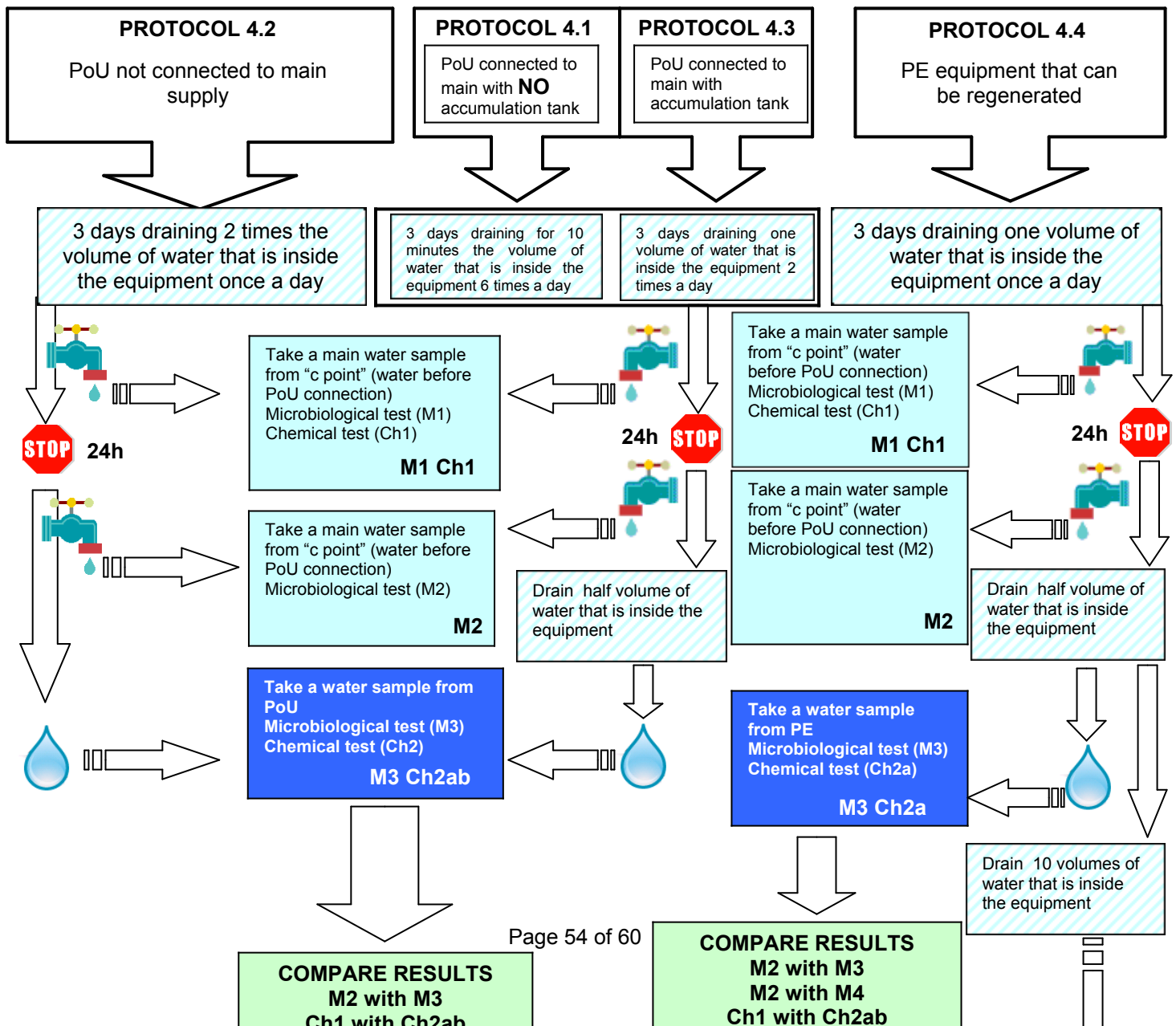



ANNEX B. PASS CRITERIA FOR CHEMICAL & MICROBIOLOGICAL PARAMETERS

ANNEX B.1 PASS CRITERIA FOR CHEMICAL PARAMETERS

Directive 98/83/EC Annex I. Part B. Chemical parameters

Parameter	PASS if Maximum Increase Between Ch1 and Ch2a	Units
Acrylamide	$\leq 0,05$	$\mu\text{g/L}$
Antimony	$\leq 2,5$	$\mu\text{g/L}$
Arsenic	$\leq 5,0$	$\mu\text{g/L}$
Benzene	$\leq 0,5$	$\mu\text{g/L}$
Benzo(a)pyrene	$\leq 0,005$	$\mu\text{g/L}$
Boron	$\leq 0,5$	mg/L
Bromate	$\leq 5,0$	$\mu\text{g/L}$
Cadmium	$\leq 2,5$	$\mu\text{g/L}$
Chromium	≤ 25	$\mu\text{g/L}$
Copper	$\leq 1,0$	mg/L
Cyanide	≤ 25	$\mu\text{g/L}$
1,2 – Dichloroethane	$\leq 1,5$	$\mu\text{g/L}$
Epichlorhydrin	$\leq 0,05$	$\mu\text{g/L}$

Fluoride	≤ 0,75	mg/L
Lead	≤ 5,0	µg/L
Mercury	≤ 0,5	µg/L
Nickel	≤ 10,0	µg/L
Nitrate	≤ 10	mg/L
Nitrite	≤ 0,25	mg/L
Polycyclic Aromatic Hydrocarbons (PAHs)	≤ 0,05	µg/L
Selenium	≤ 5,0	µg/L
Trichloroethene + Tetrachloroethene	≤ 5	µg/L
Trihalomethanes Total	≤ 50	µg/L
Vinyl chloride	≤ 0,25	µg/L

Directive 98/83/EC Annex I. Part C. Indicator parameters

Parameter	PASS if Ch2b	Units
Aluminium	< 200	µg/L
Ammonium	< 0,5	mg/L
Chloride	< 250	mg/L
Colour	< 15	mg/L Pt/Co
Conductivity	< 2500	µS/cm
Hydrogen ion concentration (pH)	Between 6,5 – 9,5	pH units
Iron	< 200	µg/L
Manganese	< 50	µg/L
Odour	< 3 (at 25°C)	Dilution Index
Oxidisability	< 5,0	mg O ₂ /L
Sulphate	< 250	mg/L
Sodium	< 200	mg/L
Taste	< 3 (a 25°C)	Dilution Index
Turbidity	< 5	UNF

Ch1: Directive 98/83/EC Annex I. Part B. Chemical parameters & Annex I. Part C. Indicator parameters

Ch2a: Directive 98/83/EC Annex I. Part B. Chemical parameters

Ch2b: Directive 98/83/EC Annex I. Part C. Indicator parameters

Ch2ab: Directive 98/83/EC Annex I. Part B. Chemical parameters & Annex I. Part C. Indicator parameters

ANNEX B.2 PASS CRITERIA FOR MICROBIOLOGICAL PARAMETERS

Directive 98/83/EC Annex I. Part C. Indicator parameters

Parameter	PASS Maximum Increase Between M2 and M3 & Between M2 and M4	Units
Colony count 22°C	≤ 2 log (*)	cfu/mL
Coliform bacteria	≤ 1 log (*)	cfu/mL

Directive 98/83/EC Annex I. Part A. Microbiological parameters

Parameter	PASS M3 & M4	Units
<i>Escherichia coli</i>	0	cfu/100 mL
Enterococci	0	cfu/100 mL

Directive 98/83/EC Annex I. Part C. Indicator parameters

Parameter	PASS M3 & M4	Units
<i>Clostridium perfringens</i>	0	cfu/100 mL

M1/M2/M3 & M4 Directive 98/83/EC Annex I. Part A. Microbiological parameters & Annex I. Part C. Indicator parameters

(*) NOTE: The observed bacteria growing increase between M1 and M2 results corresponds to bacteria growing increases from the own water for human consumption pipe.

The observed bacteria growing increase between M2 and M3 results and between M2 and M4 results corresponds to the bacteria growing increases from the tested device.

ANNEX C. OPERATIONAL SPECIFICATION STANDARDS FOR WATER TREATMENT EQUIPMENT DEVELOPED BY CEN/TC 164/WG 13

This Annex establishes specifications on water equipment operating rules developed by CEN/ 164/WG 13. They are as follows:

EN 13443-1: Water conditioning equipment inside buildings — Mechanical filters
Part 1: Particle rating 80 µm to 150 µm — Requirements for performances, safety and testing.

EN 13443-2: Water conditioning equipment inside buildings — Mechanical filters
Part 2: Particle rating 1 µm to less than 80 µm — Requirements for performance, safety and testing.

EN 14095: Water conditioning equipment inside buildings - Electrolytic treatment systems with aluminium anodes - Requirements for performance and safety and testing.

EN 14652: Water conditioning equipment inside buildings — Membrane separation devices — Requirements for performance, safety and testing.

EN 14743: Water conditioning equipment inside buildings — Softeners — Requirements for performance, safety and testing.

EN 14812: Water Conditioning Equipment inside buildings – Chemical dosing systems – pre-set dosing system - Requirements for performance, safety and testing.

EN14897: Water conditioning equipment inside buildings – Devices using mercury low-pressure ultraviolet radiators - Requirements for performance, safety and testing.

EN 14898: Water condition equipment inside buildings – Active media filters - Requirements for performance, safety and testing.

EN 15161: Water conditioning equipment inside buildings – Installation, operation, maintenance and repair.

EN 15219: Water equipment inside buildings – Nitrate removal devices - Requirements for performance, safety and testing.

ANNEX D. MATERIALS & PRODUCTS ALLOWED TO BE IN CONTACT WITH WATER FOR HUMAN CONSUMPTION

This Annex provides the material authorized to be in contact with water for human consumption. They are:

C.1 Metals

1. Copper tubes that do comply with the Standard EN 1057
2. Galvanized steel pipes that do comply with the Standard EN 10255 + A1
3. Pipes and carbon steel tanks with enough protection from internal corrosion by coatings and potential cathodic internal protection (EN 12499)
4. Cast iron pipes and reservoirs with enough protection from internal corrosion by coatings and potential cathodic internal protection (EN 12499)
5. Cast iron accessories that do comply with the Standard EN 545
6. Stainless steel pipes that do meet the UNE 19049-1

NOTES:

7. Are not allowed: Tubes and accessories contain lead whose composition except those described in UNE149101 Annex A and the maximum indicated concentration.
8. Are not allowed: Aluminium pipes.

C.2 Plastics & elastomers

1. Pipes, unplasticized polyvinyl chloride (PVC) that do comply with the Standard EN ISO 1452
2. Polyvinyl chloride pipes chloride (PVC-C) that do comply with the Standard EN ISO 15877
3. Polyvinyl chloride pipes oriented (PVC-O) that do comply with the ISO 16422

4. Polyethylene pipes (PE) that do comply with the Standard EN 12201
5. Polyethylene pipes temperature resistance (PE-RT) that do comply with the Standard EN ISO 22391
6. Reticulated polyethylene pipes (PE-X) that do comply with the Standard EN ISO 22391
7. Polybutylene pipes (PB) that do meet the standard EN ISO 15876
8. Polypropylene tubes (PP) that do comply with the EN ISO15874
9. Multilayer tubes that do comply with the Standard EN ISO 21003
10. Elastomeric seals that do comply with the Standard EN 681

*** * ***